



64FDC

Floppy

Disk

Controller

Instruction

Manual

Cromemco[®]

64FDC

Instruction Manual

**CROMEMCO, Inc.
280 Bernardo Avenue
Mountain View, CA. 94043**

Part No. 023-2022

March 1983

**Copyright © 1983
CROMEMCO, Inc.
All Rights Reserved**

TABLE OF CONTENTS

INTRODUCTION	1
Chapter 1: GETTING STARTED WITH THE 64FDC	3
Switches and Jumpers	3
Switch-Selectable Options	3
Jumper-Selectable Options	4
Cables	5
Formatting Diskettes	7
Index Holes	7
Write Protection	7
Starting the System	9
Chapter 2: RDOS	11
Command Format	11
Swath Operator	12
Alignment Option	12
Boot	13
Display Memory	14
Examine Input Port	14
Go	14
Initialize Baud Rate	15
List All Disks Logged In	15
Move	15
Output	16
Query	16
Read Disk	16
Set Disk Side	17
Seek	17
Select Disk Drive	18
Substitute Memory	20
Test System	21
Verify	21
Write Disk	22
RDOS Select	22
Chapter 3: REGISTER DESCRIPTIONS	25
Chapter 4: INTERFACE CHARACTERISTICS	51
Serial Channel - Interface Characteristics	52
8" and 5" Disk Drive - Interface Characteristics	53
Outputs from the 64FDC	53
Inputs to the 64FDC	54

Chapter 5: INITIAL SETUP	55
Tandon TM848	55
Tandon TM100	58
Chapter 6: THEORY OF OPERATION	59
Power Supplies	59
Address Decode	59
Data Bus	59
Wait-State Generator	60
Clocks	61
Bank Select	61
TMS5501 Interfaces	61
FD1793-1 Interfaces	61
Write Precompensation	62
Priority Chain	62
Auto Wait	62
Motor Timer	63
Phase-Locked Loop	63
Mode 2 Interrupt Acknowledge	65
Real-Time Clock	66
Appendix A: TUNING THE DATA SEPARATOR	67
INDEX	69
SCHEMATIC	
LIMITED WARRANTY	

LIST OF FIGURES

Figure 1-1:	64FDC Switches, Jumpers, and Cable Connections	6
Figure 1-2:	Floppy Diskettes	8
Figure 2-1:	RDOS Select	23
Figure 3-1:	DRQ and RTC Jumper Locations	31
Figure 5-1:	TM848 Setup	57
Figure 5-2:	TM100 Setup	58

INTRODUCTION

The 64FDC, Cromemco's third-generation floppy disk controller board, offers substantial feature and benefit improvements. The 64FDC provides a complete system for floppy disk operation: serial I/O for an RS-232 terminal, a read only memory programmed with system bootstrap and diagnostic routines, and full read/write/format capability for any combination of single or double sided, single or double density, 5" (mini) or 8" (maxi) floppy disks. The 64FDC normally handles up to 4 drives in a daisy-chain configuration, although 16 drives may be chained if the drives decode the 4 drive-select lines.

The 64FDC has fewer parts than its predecessor, the 16FDC, and is therefore more reliable. Yet it has more features.

The 64FDC supports the new slimline eight-inch drives such as those featured in the Cromemco System 3A. It also includes write precompensation to ensure that it works reliably on the inner tracks of a wide variety of eight-inch drives.

All timing on the 64FDC is referenced to an onboard crystal clock. This includes the head-stepping rate, the motor-turnoff timer, interval timers, the watchdog timer in the auto wait circuit, and the precompensation delay in the write circuit.

The 64FDC includes an 8-channel interrupt system connected to the flag bits of the disk controller. One of the interrupt inputs can be connected to the crystal clock for use with the real-time multiuser, multitasking Cromix Operating System.

Single-density data is recorded in the FM format while double-density data uses the MFM format. Density on a given diskette may vary from track to track. Such dual-density diskettes often require the first track to contain a disk type specifier, written in single density, which informs the operating system of the density and number of sides of the remainder of the diskette.

The data-recovery circuit uses Cromemco's patented phase-locked loop to optimize performance for each size and density diskette. The phase-locked loop circuitry incorporates an adjustable trimmer capacitor that is clearly visible on the circuit board. This trimmer capacitor is adjusted at the factory. The setting of this capacitor can only be adjusted by trained personnel using special test equipment. **THE USER MUST NOT ATTEMPT TO ADJUST THE TRIMMER CAPACITOR.**

Chapter 1

GETTING STARTED WITH THE 64FDC

Most users of the 64FDC will be running under the Cromemco Disk Operating System (CDOS) or the Cromemco Cromix Operating System. For these users, getting started with the 64FDC is simply a matter of setting the switches and plugging in the cables. This chapter explains these operations.

SWITCHES AND JUMPERS

The 64FDC board has five switches and four jumper locations to allow the user control over the various options described below.

Switch-Selectable Options

Switch 1 is normally OFF, so that the baud rate is not pre-set. If switch 1 is ON, the baud rate will be automatically set to 300 baud. This allows automatic bootup operation of a dedicated system not having a system terminal attached to the 64FDC or automatic sign-on of a modem.

Switches 2, 3, and 4 indicate to RDOS which disk drive to use for the boot sequence. The following table shows all possible combinations.

Switch 2	Switch 3	Switch 4	Drive
OFF	OFF	OFF	Floppy disk A
OFF	OFF	ON	Floppy disk B
OFF	ON	OFF	Floppy disk C
OFF	ON	ON	Floppy disk D
ON	OFF	OFF	reserved
ON	OFF	ON	reserved
ON	ON	OFF	reserved
ON	ON	ON	reserved

Switch 5 ON automatically starts the RDOS self-test procedure (described in Chapter 2) upon power-on or reset. If switch 5 is OFF, the **T** (Test System) command can still be given manually to start the self-test.

Table of Standard Switch Settings

Switch	Position	Function
1	OFF	} boot from floppy disk drive A
2	OFF	
3	OFF	
4	OFF	
5	OFF	
		automatic self-test not enabled

Jumper-Selectable Options

The four jumper locations on the 64FDC control options involving the CDOS and Cromix Operating Systems. These jumper locations are directly above the five switches. (Refer to Figure 1-1.)

Jumper location 1 is the RDOS DEFEAT control. There is no jumper or solder trace at this location. Without a jumper, the RDOS program is loaded into memory and can be used to bootstrap the operating system upon power-on or reset.

Jumper location 2 is the control for DISABLE RDOS AFTER BOOT. There is a solder trace at this location. This causes RDOS to be removed from memory space when the operating system is booted up.

Jumper location 3 is the AUTOMATIC BOOT control. There is a solder trace at this location. This causes RDOS to load the operating system automatically upon power-on or reset. If the trace is cut, RDOS enters a diagnostic monitor mode and waits for further commands.

Jumper location 4 INHIBITS INITIALIZATION of floppy or hard disks. There is no jumper or solder trace at this location. This allows diskettes to be formatted.

Table of Standard Jumper Connections

Location	Jumper	Function
1	no	RDOS is not defeated
2	yes	RDOS disabled after boot
3	yes	operating system loads automatically
4	no	operating system can format diskettes

CABLES

A 26-wire ribbon cable connects the RS-232 socket at the back of the computer to the 64FDC. This cable should be plugged into the serial connector (J4) of the 64FDC. The cable has a stripe along one edge. This stripe faces left, toward the center of the 64FDC, as indicated on the board.

The disk signal cables must be connected to the proper jacks on the 64FDC board. If you have 8" drives, the cables will have 50 wires; if you have 5" drives, the cables will have 34 wires. Connect these cables to their jacks (J3 and J2 respectively). Ensure that the cable stripe is to the left.

Finally, connect the priority interrupt cable to connector J1. This step is necessary if you are running the Cromix Operating System with an IOP, PRI, TU-ART, or other boards capable of generating interrupts. The cable must go from the priority interrupt cable connector **out** pin on the 64FDC board to the **in** pin on the next board in sequence, and so on. The priority interrupt cable should run from the 64FDC to the TU-ART(s) to the IOP(s) to the PRI.

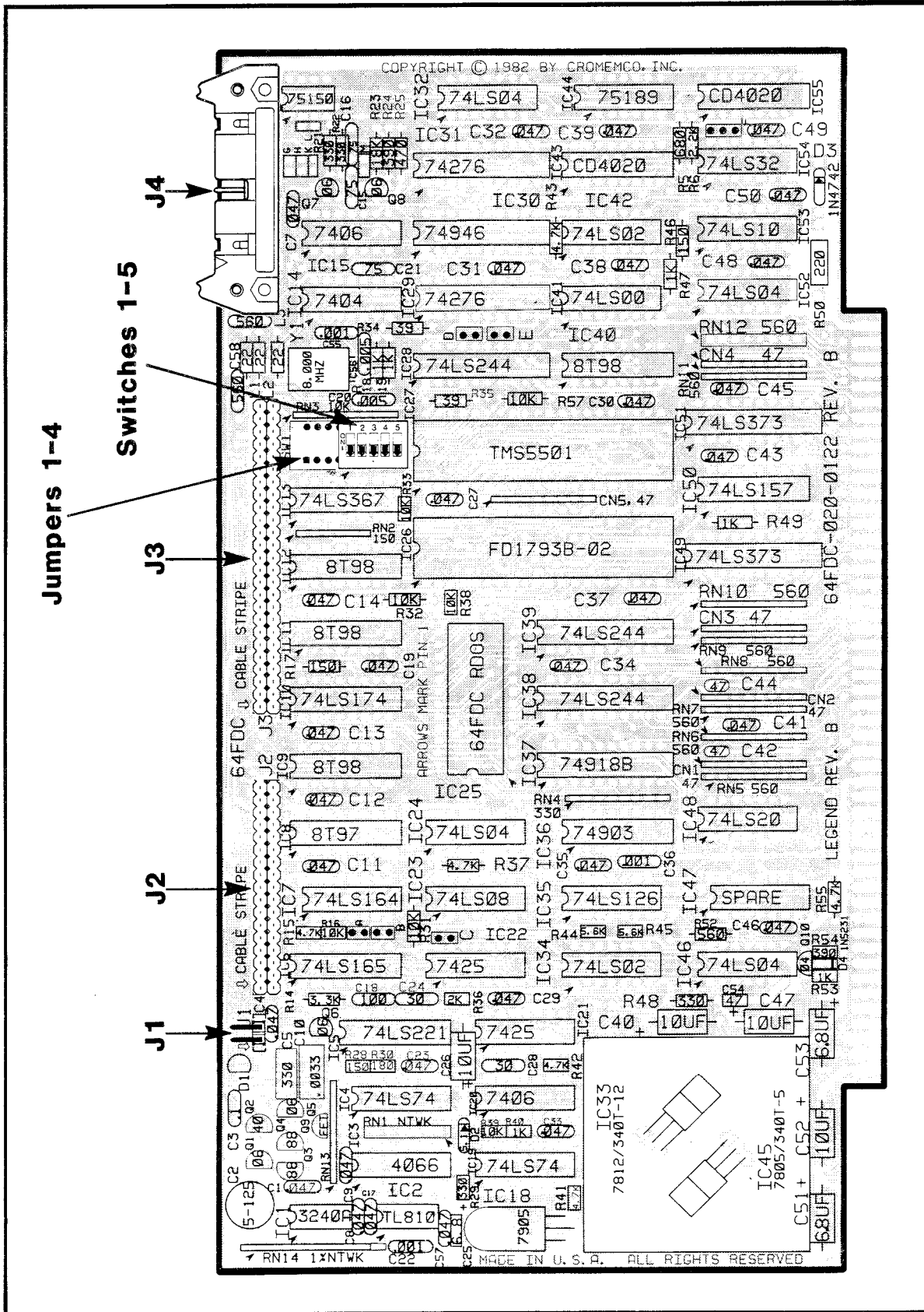

Figure 1-1: 64FDC SWITCHES, JUMPERS, AND CABLE CONNECTIONS

FORMATTING DISKETTES

The 64FDC has strict diskette formatting standards and can read only those diskettes that have been properly formatted. This means the 64FDC may not be able to read small (5.25-inch) diskettes that were formatted using a 4FDC disk controller. It also may not be able to read large (8-inch) diskettes that were formatted with the wrong index hole covered. The following procedures will assist users who encounter either of these problems.

Floppy diskettes that cannot be read by the 64FDC because of improper format must be copied to properly formatted diskettes using the 4FDC. A properly formatted small diskette is one that has been formatted using the **Init** program, version 2.15 or higher. A properly formatted large diskette is one that has been formatted using the **Init** program, version 2.15 or higher, with the proper index hole exposed (refer to the following paragraph on index holes). After it has been determined that the copied diskettes can be read by the 64FDC, the old diskettes may be reformatted using the 64FDC and the data copied back, if desired.

INDEX HOLES

Cromemco large (8-inch) double sided, double density floppy diskettes have two index holes. The hole closest to the top of the diskette should be **exposed** when using the diskette as single sided. The hole to the right should be **exposed** when using the diskette as double sided. **Cromemco strongly recommends that only the correct index hole be exposed before using an 8-inch diskette.** Cromemco supplies special foil-backed labels for covering the hole not being used. Using the old paper-backed labels may cause errors with certain drives. You can identify the new labels by peeling off the paper backing to expose the label's sticky surface. This surface is silver on the new labels and white on the old labels.

WRITE PROTECTION

The 64FDC, when used in conjunction with a Cromemco floppy disk drive, can provide diskette write protection.

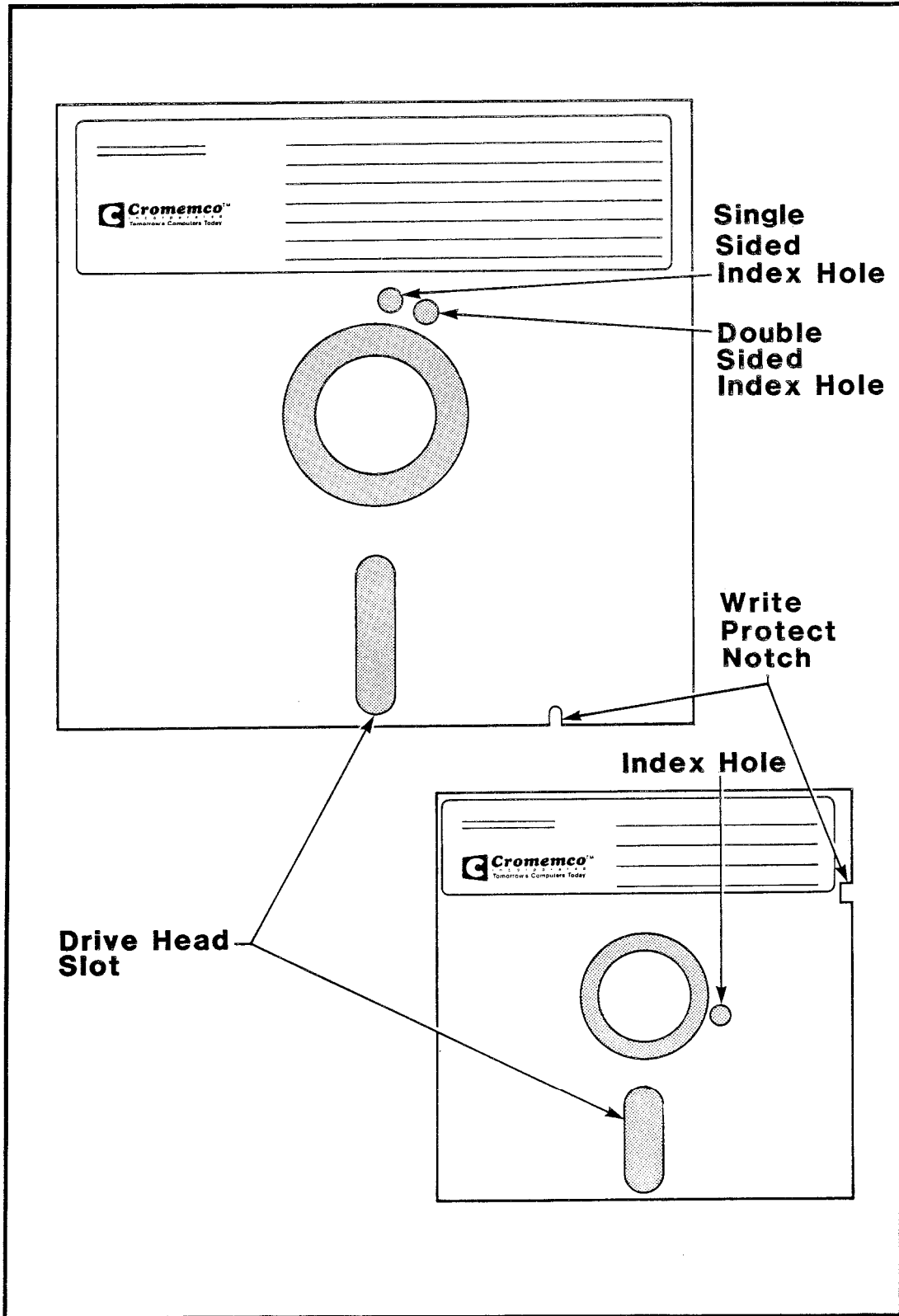

Figure 1-2: FLOPPY DISKETTES

An 8-inch diskette is write protected if the write protect notch is **not** covered. A 5.25-inch diskette is write protected if the write protect notch **is** covered.

STARTING THE SYSTEM

With all cables installed and the switches set, the 64FDC is ready for operation. If you are using a ZPU board, set the Power-On Jump switches (refer to the Cromemco ZPU manual, part number 023-0012) so that execution will begin at C000h (start of RDOS). If you are using a DPU board, the power-on address is factory set to C000h. Set the switches on the RAM board(s) so that memory at 8000h to FFFFh is disabled and memory from 0000h to 1000h (or more) is enabled upon reset.

Now apply power to the system and insert a disk containing the operating system into drive A. RDOS will print out a sign-on message after determining the baud rate of the terminal. (Note: if you are not using a Cromemco 3102, C-1, or C-10 Video Terminal, it will be necessary to press the RETURN key on your terminal several times so that the 64FDC can determine the baud rate.)

After sign-on is complete, RDOS will display the message "Preparing to boot, ESC to abort", indicating the boot command has been received. RDOS will then pause for a few seconds while determining the type of disk drive specified (8" or 5") and the type of seek. Once RDOS has read the system boot information from the disk into memory, it will display "Standby", indicating that the boot is proceeding normally.

At this point, you might also receive the message "No boot", indicating that the disk being used does not contain the boot information; or the message "Unable to boot", indicating that RDOS is unable to read the boot information from the disk. Either of these two conditions must be remedied by booting from another disk and then correcting or repairing the original disk.

Between display of the messages "Preparing to boot" and "Standby", the operator may abort the boot (even if it is an automatic sequence) and return control to RDOS by pressing the ESCAPE key on the keyboard. If the boot is not aborted and proceeds normally, the operating system being used should come up and display its prompt.

Chapter 2

RDOS

The Cromemco Resident Disk Operating System II (RDOS) is a 4K-byte or 8K-byte program supplied in ROM with each Cromemco model 64FDC disk controller board. The RDOS program is designed to execute beginning at memory location C000h.

COMMAND FORMAT

All commands must be terminated by pressing the RETURN key. RDOS will not respond to any command until the command is properly terminated with a RETURN.

The normal prompt of the monitor is a semicolon (;). If a disk drive is selected, the prompt changes in order to remind the user which drive is current. All disk commands refer to the drive most recently selected.

The command format is generally free form with respect to spaces. Specifically, spaces within the command string are ignored, but spaces must not be embedded inside numeric arguments.

Wherever a numeric value is expected, a decimal integer may be specified by following the number with a decimal point (e.g., 123.). If no decimal point is present, the number is assumed to be hexadecimal.

Console input is line buffered, allowing use of the following editing commands:

Backspace	Deletes previous character
CONTROL-U	Deletes current input line
Backarrow or Underline	Same as Backspace
Delete or Rubout	Same as Backspace

CONTROL-P may be used at any time to start or terminate the echoing of terminal output to the printer. The printer must be a dot-matrix printer, such as the Cromemco Model 3703. RDOS does not support the use of fully formed character printers, such as the Cromemco Model 3355A.

CONTROL-S may be used to suspend the display, with another **CONTROL-S** (or any other character) used to resume the display.

ESCAPE or **RETURN** may be used to abort the display and return control to RDOS.

SWATH OPERATOR

Commands requiring multiple address arguments may be specified in one of two ways: either by explicitly declaring the start & stop addresses, or by declaring the start address and the swath (or width). This is done by following the start address with the letter **S** and the swath width. For example, the following two commands are identical in function:

DM 100 142	Display memory starting at 100h through 142h
DM 100 S 43	Display memory starting at 100h for 43h bytes

ALIGNMENT OPTION

A ON
A OFF

This command is used to force disk select on a continuous basis. **A ON** enables the option, **A OFF** disables it. This command is used when aligning disk drives. When the option is enabled, the current drive will be selected and stay selected until the option has been disabled. In this mode the user may perform all of the usual disk operations.

BOOT

The format of this command when given manually is

Bx

followed by a RETURN, where **x** is an optional disk drive specifier. If **x** is omitted, RDOS will boot from the drive specified by switches 2, 3, and 4 of the 64FDC disk controller (see switch settings in Chapter 1).

The parameter **x** should be a floppy disk drive letter (in the range A through D). If this parameter is specified, RDOS will attempt to boot from that drive. For example, the command **BC** will attempt to boot the system from drive C.

The boot command may also be performed automatically. This option is enabled by a jumper in jumper location 3, as described in Chapter 1.

After sign-on is complete (whether manual or automatic), RDOS will display the message **"Preparing to boot, ESC to abort,"** indicating that the boot command has been received. RDOS will then pause for a few seconds while determining the type of disk drive specified (8" or 5") and the type of seek. Once RDOS has read the system boot information from the disk into memory, it will display **"Standby,"** indicating that the boot is proceeding normally.

At this point, you might also receive the message **"No boot,"** indicating that the disk being used does not contain the boot information; or the message **"Unable to boot,"** indicating that RDOS is unable to read the boot information from the disk. Either of these two conditions must be corrected by booting from another disk and then correcting or repairing the original disk.

Between display of the messages **"Preparing to boot"** and **"Standby,"** the operator may abort the boot (even if it is an automatic sequence) and return control to RDOS by pressing the ESCAPE key on the keyboard. If the boot is not aborted and proceeds normally, the operating system being used will come up and display its prompt.

DISPLAY MEMORY

DM
DM start
DM start finish
DM start S swath
DM S swath

The contents of memory are displayed in hexadecimal and ASCII. Each line of the display is preceded by the address of the first byte. The ASCII portion is displayed to the right of the hexadecimal part, with bit 7 set to 0. Any nonprinting ASCII characters are displayed as a period (.).

The first form of the command will display 80h bytes starting with the ending address of the previous DM command plus 1, or 100h bytes if no DM command has been given yet. The second form will display 80h bytes from the address specified. The third form will display from start to finish as specified. The fourth form will display **swath** bytes beginning at start. The last form will display **swath** bytes starting with the ending address as above.

The default swath width for the DM command is 80h (128 decimal) bytes. The letter M following the D is optional.

EXAMINE INPUT PORT

E port

Displays the current contents of the specified input port.

GO

G addr

Begins execution starting at **addr**.

INITIALIZE BAUD RATE

I

After the I command and the following RETURN are typed, change the baud rate of the terminal to the desired value and then type RETURNS until the monitor responds with its prompt. On Cromemco 3102 terminals, RDOS establishes the baud rate by sending a <BREAK> to the terminal, thus eliminating the need for the user to type RETURNS to set the baud rate. The monitor is capable of selecting 19200, 9600, 4800, 2400, 1200, 300, 150, or 110 baud. The maximum number of RETURNS required is four. During this process, any character other than the RETURN is ignored. If switch 1 is set, then the baud rate will be automatically set to 300 baud. This is so a modem can be used instead of a terminal, not requiring the use of RETURNS to initialize the baud rate.

LIST ALL DISKS LOGGED IN

L

List details of all disks logged in, in the following format:

Drive \$1, Size \$2, \$3 Sided, \$4 Density, \$5 Seek, Cromix
where:

\$1 is drive letter **A** through **D**
\$2 is **L** or **S** for Large or Small
\$3 is **S** or **D** for Single or Double Sided
\$4 is **S** or **D** for Single or Double Density
\$5 is **F**, **M**, or **S** for Fast, Medium, or Slow

Cromix is printed if the disk is formatted for use with the Cromix Operating System.

MOVE

M source finish dest
M source S swath dest

Move (or copy) the contents of memory beginning with **source** and ending with **finish** to memory beginning at **dest**. After the move, the monitor will verify that the source and destination are the same. After certain types of overlapping moves, this will result in a display of discrepancies (which are not really errors).

This printout can be terminated by pressing the ESCAPE key.

The move command can be used to fill a block of memory with a constant. For example, to enter zeros between locations 100h and 108h, use the **SM** command to enter 0 at location 100h, and then move 100h through 107h to 101h:

```
M 100 107 101  or
M 100 S 8 101
```

OUTPUT

O byte port

Writes **byte** to the output **port** specified.

QUERY

```
Q start finish string of bytes
Q start S swath string of bytes
```

This command is used to search the specified memory for a given string of bytes. The string of bytes is in the same format as in the **SM** command. If the string of bytes is found, 16 bytes are displayed, starting at the first byte which matches.

READ DISK

```
RD start finish sector
RD start S swath sector
```

Before this command will be accepted, the disk drive, side number, and track number must have been specified. (See the Select Disk, Seek and Set Side commands.)

This command reads enough sectors from disk to fill the specified memory area, starting with the specified sector of the current track. The first track, sector and side read, and the last track, sector and side read are then displayed (e.g., 1D01 0 1D02 0).

If the last sector on the last track is read before the memory area is filled, then the following message is displayed:

Next Memory: nnnn
End of Disk

where **nnnn** is the next location to be read into. The command is then terminated.

The command is also terminated if an error occurs in reading a sector. In this case the message **Rnn** is printed, where **nn** is a hex number which indicates the status:

Bit Indication

7	Not Ready
6*	0
5*	Record Type
4	Record Not Found
3	CRC Error
2	Lost Data
1*	Data Request
0*	Busy

*These are not really errors, but they should not be set after a read command.

SET DISK SIDE

SX side

The current drive is set to the side specified. If the current drive is single sided, a question mark will be displayed and the command terminated.

SEEK

S track	e.g., S 28. Seek track 28 (decimal)
S track side	e.g., S 1C 1 Seek track 1C (hex) on side 1
SS side	e.g., SS 1 Set side to 1

Before this command will be accepted, the disk drive must be specified. (See the Select Disk command.)

This command seeks the specified track of the current drive. The first form will seek on the current side; the second form will select the side before seeking.

If the second form is specified with a single-sided drive or disk, an error message will be printed and the operation terminated.

In the third form the current drive is set to the side specified. If the current drive is single sided, a question mark will be displayed and the command terminated.

Bit Indication

7	Not Ready
6*	Write Protect
5*	Head loaded
4	Record Not Found
3	CRC Error
2*	Track 0
1*	Index
0*	Busy

*These are not really errors.
Busy should not be set after the command is completed.

SELECT DISK DRIVE

The 64FDC will control up to 4 disk drives, labelled **A**, **B**, **C**, and **D**. It can handle seeks from the slow seek appropriate to the mini floppy to the medium seek of Cromemco's large floppy. It can also handle the fast seek of some other large floppies.

It can handle single-density or double-density format, and double-sided as well as single-sided drives and disks, including disks with the Cromemco Cromix Operating System format.

To select a drive, type the drive name followed by 2 semicolons for large disk and medium seek, or 3 semicolons for small disk and slow seek, followed optionally by the sides/density/Cromix configuration. These options are specified as follows:

d;xyz

where:

d is the drive name
x is S or D for Single/Double sided
y is S or D for Single/Dual density
z is C for Cromix (optional)

Side/Density options **must** be specified together. Cromix may be specified only if Side and Density are specified.

Examples:

A;;DS Specifies drive A with medium seek, double sided, single density
D;;;SDC Specifies drive D with slow seek, single sided, double density, Cromix

If no options are given, RDOS will read the label from the disk and log it in with the specification given on the label.

Disk selection also restores the disk-drive head to home, track 0. If an error is made in doing this, the message **Hnn** is printed, where **nn** is a hex number indicating the status:

<u>Bit</u>	<u>Indication</u>
7	Not Ready
6*	Write Protect
5*	Head loaded
4	Record Not Found
3	CRC Error
2*	Track 0
1*	Index
0*	Busy

*These are not really errors.
Busy should not be set after the command is completed.

SUBSTITUTE MEMORY

SM
SM addr

This command is used to substitute memory. The first form will substitute memory at the last location substituted plus 1, (100h if no **SM** command has been given yet); the second form will substitute at the address specified. RDOS displays the address, followed by the contents of the memory byte. One of the following may then be entered:

1. A data-byte value followed by a RETURN. The data-byte value is stored at the address of the prompt. The address is then incremented by 1 and displayed on the next line.
2. A string enclosed between apostrophes ('), followed by a RETURN. The string is stored beginning at the address of the prompt. The address is then incremented past the string and displayed on the next line.
3. Any number of 1 and 2 above can be entered on one line with just one RETURN terminating the line. The address is then incremented past the bytes that were stored and the new address is displayed on the next line.
4. A minus sign (-). A minus sign does not store a byte. The address will be decremented to the previous address. The minus sign can be used to back up to a previous location in case an error was made.
5. A RETURN only. If no entry is made on the line, the memory byte remains unchanged. The address is incremented by 1 and displayed on the next line.
6. A Period (.). A period ends the input mode and returns control to RDOS.

Wherever a numeric value is expected, a decimal integer may be specified in place of a hexadecimal value by following the number with a decimal point (e.g. 123.).

TEST SYSTEM

T
TZ

The first command moves RDOS out of ROM into the bottom of RAM (lower 16K), enables the upper block of RAM, and moves RDOS back into RAM at C000h. It then performs a routine check of the system memory and the operation of the 64FDC. The memory check will display a map of all 4K blocks of available memory, followed by a map of which blocks have errors or no errors. A check is then made of the 64FDC seek, read, and write operations, with results being displayed on the console. The drive used in the test is prompted for by the test command, and remains selected when the test terminates.

The second command does not move RDOS into RAM, and may be used to test systems with no RAM at C000h.

Note that after executing the first command, RDOS resides in RAM. The user should exercise caution so as not to overwrite this part of RAM.

VERIFY

V source finish dest
V source S swath dest

Verify that the block of memory starting at **source** through **finish** (or for length **swath**) is the same as the block starting at **dest**. The addresses and contents are displayed for each discrepancy found.

The command works by reading bytes from the source and destination and comparing them. If a discrepancy is found, it is displayed in the following order: source address, source contents, dest contents, dest address.

WRITE DISK

WD start finish sector
WD start S swath sector

Before this command will be accepted, the disk drive, side number, and track number must have been specified. (See the Select Disk, Seek, and Set Side commands.)

This command writes the contents of the specified memory area to the current drive, starting with the specified sector of the current track. The first track, sector, and side written, and the last track, sector, and side written are then displayed (e.g., 2045 1 2503 1).

If the last sector on the last track is written before the memory area has been read then the following message is displayed:

Next Memory: nnn
End of Disk

where **nnn** is the next location to be written from. The command is then terminated.

The command is also terminated if an error occurs in writing a sector. In this case the message **Wnn** is printed, where **nn** is a hex number which indicates the status:

<u>Bit</u>	<u>Indication</u>
7	Not Ready
6	Write Protect
5	Write fault
4	Record Not Found
3	CRC Error
2	Lost Data
1*	Data Request
0*	Busy

*These are not really errors.

RDOS SELECT

To use your own 2732 (TMS 2532) EPROM in the RDOS socket, cut the trace at F (see Figure 2-1) and install the jumper in the adjacent pads. This puts +5 volts at pin 21. On a 2764 or other 64K ROM, pin 21 is A12. On the 2732, pin 21 is VPP, the programming voltage, and should go to +5 for normal (read only) operation.

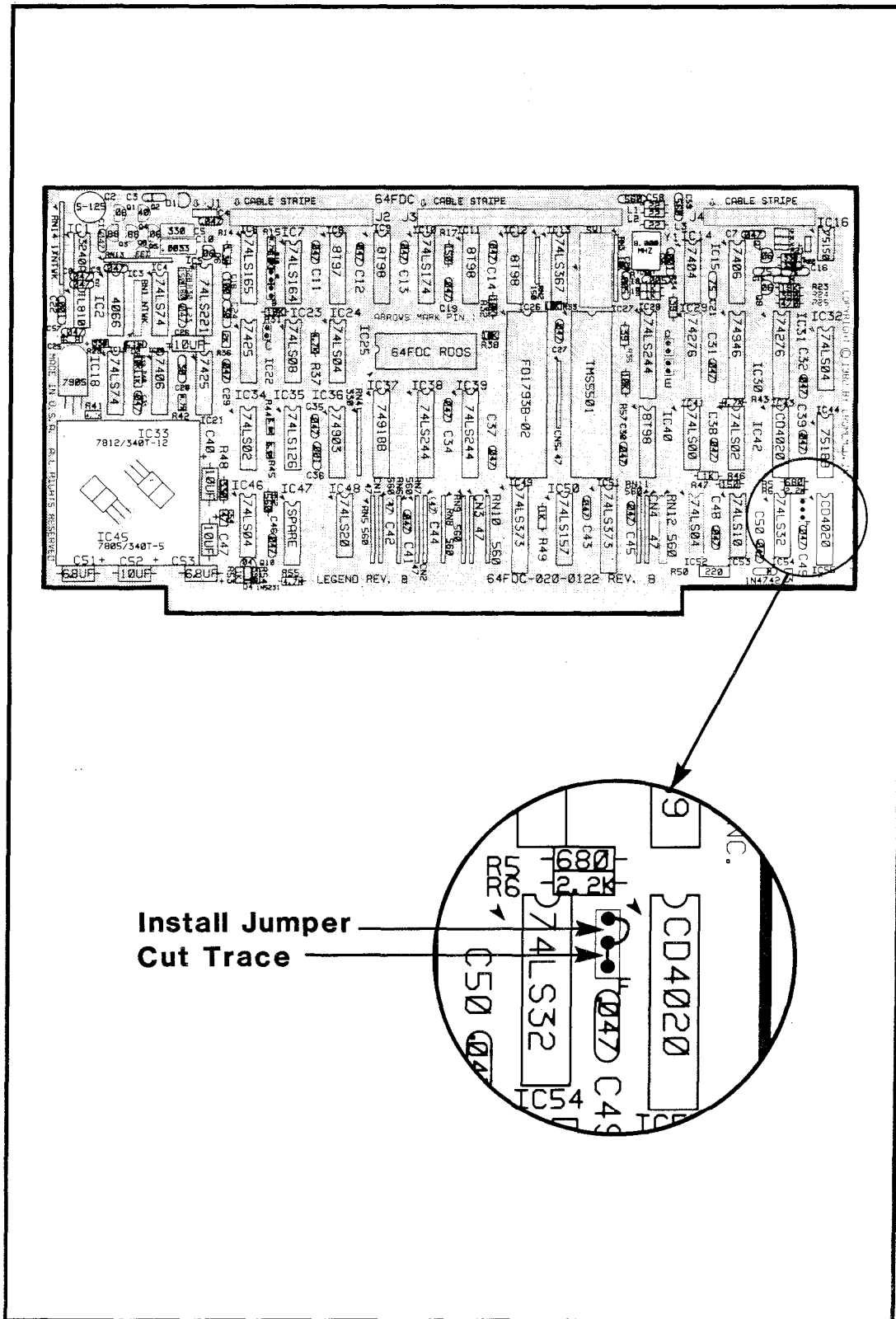

Figure 2-1: RDOS SELECT

Chapter 3

REGISTER DESCRIPTIONS

The registers of the 64FDC will be discussed in numerical order according to their I/O addresses shown below:

I/O Address (hex)	INPUT	OUTPUT
00	UART status register	UART baud rate
01	UART receiver data register	UART data
02	not assigned	UART command
03	Interrupt address	Interrupt mask
04	Auxiliary disk status	Auxiliary disk command
05	not assigned	Timer 1
06	not assigned	Timer 2
07	not assigned	Timer 3
08	not assigned	Timer 4
09	not assigned	Timer 5
30	DISK status	DISK command
31	DISK track	DISK track
32	DISK sector	DISK sector
33	DISK data	DISK data
34	DISK flags	DISK control
40	not assigned	Bank select

00 IN STATUS REGISTER:

Status flags from the TMS5501 UART.

D7 Transmitter Buffer Empty
D6 Receiver Data Available
D5 Interrupt Pending
D4 Start-Bit Detect

D3 Full-Bit Detect
D2 Serial Receive
D1 Overrun Error
D0 Frame Error

The functions of these flags are described in the following sections.

D7 Transmitter Buffer Empty (TBE):

A high in bit 7 indicates that the transmitter data buffer is ready to accept a new byte. TBE goes high as soon as the serial transmitter begins to send the byte currently in the buffer. Since the transmitter is "double buffered", the user may respond to the TBE signal and load the buffer even before the previous byte has been totally transmitted. TBE also activates interrupt-request bit 5 (refer to the Interrupt Mask). TBE is cleared when the buffer is loaded, and is set by the RESET command.

D6 Receiver Data Available (RDA):

A high in bit 6 indicates that a byte of data is available from the receiver buffer. This flag remains high until the buffer is read. A RESET command clears the flag. If the buffer is not read by the time the next byte from the receiver is ready, the new byte will write over the old byte and the overrun error flag will be set. RDA also activates interrupt-request bit 4 (refer to the Interrupt Mask).

D5 Interrupt Pending (IPG):

A high in bit 5 indicates that one or more of the eight interrupt-request sources has become active. This flag goes high at the same time as the interrupt-request pin of the TMS 5501 UART.

D4 Start-Bit Detect (SBD):

A high in bit 4 indicates that the serial receiver has detected a start bit. This bit remains high until the full character has been received. SBD is cleared by the RESET command. This bit is provided for test purposes.

D3 Full-Bit Detect (FBD):

The FBD flag in bit 3 goes high one full bit time after the start bit has been detected. This bit remains high until the full character has been received. FBD is cleared by a RESET command. This bit is provided for test purposes.

D2 Serial Receive (SRV):

A high in bit 2 indicates a high level on the serial data input line. A low in bit 2 indicates a low level on the serial data input line. SRV is high when no data is being received. This bit is provided for break detection and for test purposes.

D1 Overrun Error (ORE):

A high in bit 1 indicates that the receiver has loaded the receiver data buffer before the previous contents were read. ORE is cleared after the status port is read, or by the RESET command.

D0 Frame Error (FME):

A high in bit 0 indicates an error in one or both of the stop bits which "framed" the last-received data byte. FME remains high until a valid character is received.

00 OUT BAUD RATE REGISTER:

Loading this register sets the baud rate and stop bits for serial receive and transmit data. The bits are assigned as follows:

D7 STOP BITS
D6 9600
D5 4800
D4 2400

D3 1200
D2 300
D1 150
D0 110

D7 Stop

A high in bit 7 selects one stop bit for serial receive and transmit data. A low in bit 7 selects two stop bits.

D6-D0 Baud Rate

A high in one of the lower seven bits selects the corresponding baud rate. If more than one bit is high, the highest rate selected will result. If none of the bits are high, the serial transmitter and receiver will be disabled. (For special purposes, the baud rates can be octupled--see the description of HBD in the command register.)

01 IN RECEIVER DATA:

This register contains an assembled byte of data from the serial receiver.

01 OUT TRANSMITTER DATA:

This register is loaded with data for the serial transmitter.

02 IN Not Assigned:

Reading this port causes no response from the 64FDC. This address is available for other purposes.

3. Register Descriptions

2 OUT COMMAND REGISTER:

The command-register format is shown below.

D7 Not Used	}	L a t c h e d
D6 Not Used		
D5 Test		
D4 HIGH BAUD		
D3 INTA Enable		
D2 RST7 Sel.		
D1 Break		
D0 Reset		

D5 Test Bit (TB5):

A high in bit 5 disables the internal interrupt priority logic and then enables the internal clock. Thus, the signal on the INT pin of the 5501 becomes a TTL level clock of 15.625 kHz (125 kHz if HBD is high--see D4 High Baud below). TB5 should be low for normal operation.

D4 High Baud (HBD):

A high in bit 4 octuples the rate of the internal clock. This causes the interval timers to count eight times faster and the serial data rates to increase eightfold. When bit 4 is high, baud rates up to 76800 are available for high-speed data transfers.

D3 INTA Enable (INE):

A high in bit 3 allows the 5501 to respond to an Interrupt Acknowledge by gating a Restart instruction onto the data bus at the correct time and resetting its internal interrupt-request latch.

A low in bit 3 prevents the 5501 from detecting an INTA cycle.

D2 RST7 Select (RS7):

A high in bit 2 connects the MSB of the parallel-input port to the interrupt-request latch for the lowest-priority interrupt (interrupt 7). A low-to-high transition on the MSB of the parallel-input port (XI7) will activate the interrupt-request latch. The 64FDC provides an optional jumper to connect DRQ from the disk to XI7. When the jumper is inserted and RS7 is high, DRQ's from the disk will generate interrupts.

Another jumper (already inserted) connects a 512-millisecond clock to XI7. With this jumper (RTC) inserted, when RS7 is high interrupts will be generated every 512 milliseconds.

Either the DRQ or the RTC jumper may be connected, **but not both**. Figure 3-1 shows the locations for these jumper connections.

A low in bit 2 connects the output of Timer 5 to the interrupt-request latch for the lowest-priority interrupt (interrupt 7). When the timer count reaches zero, the interrupt-request latch will be activated.

D1 Break (BRK):

A high in bit 1 holds the serial-transmitter output in the low state (spacing). RES will override (see D0 Reset below).

BRK should be low for normal operation.

D0 Reset (RES):

A high in bit 0 causes the following actions:

1. The serial receiver goes into search mode; RDA, SBD, FBD, and ORE are set to zero. The contents of the receiver buffer are not affected.
2. The serial transmitter output is set high (marking). If D0 (RES) and D1 (BRK) are both high, the RES function will override. RES sets TBE high.
3. The interrupt register is cleared except for the TBE interrupt request which is set high.
4. The interval timers are cleared. RES is not latched.

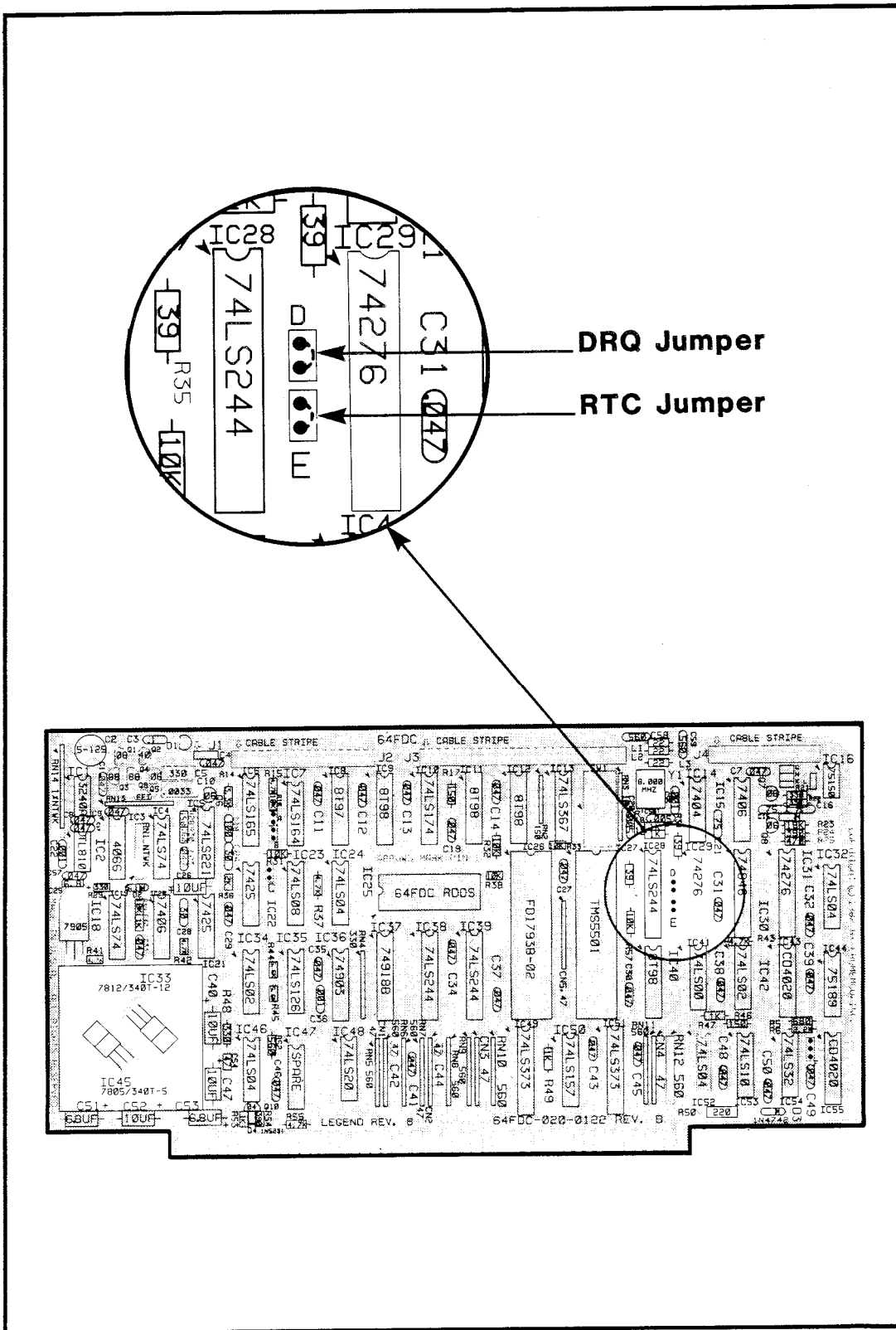

Figure 3-1: DRQ AND RTC JUMPER LOCATIONS

03 IN INTERRUPT ADDRESS:

This register contains the encoded address of the highest-priority interrupt currently requesting service. This address is identical to the "Restart" instruction opcode for the interrupt acknowledge. Thus, the register contents may be (in order of service priority):

HEX SOURCE

C7 Timer 1
CF Timer 2
D7 End of job (From disk)
DF Timer 3
E7 Receiver Data Available
EF Transmitter Buffer Empty
F7 Timer 4
FF Timer 5 or DRQ from disk or real-time clock

This register is provided for servicing interrupts via polling. After the register is read, the corresponding bit in the interrupt-request register is reset. If the register is read when no interrupt is pending, it will read 0FFh.

03 OUT INTERRUPT MASK:

The contents of this register are logically ANDed with output from the interrupt-request register on the 5501. A high bit in the interrupt mask allows the corresponding request to pass on into the priority encoder. A low bit in the interrupt mask inhibits the corresponding interrupt from passing any further. Since the interrupt requests are latched independently of the state of the mask, an interrupt may be requested while the mask bit is low. The request will be retained until the mask is changed and the request is allowed to pass on (assuming no RES command in the interim). The mask bit assignments are:

D7 Timer 5 or DRQ or real-time clock
D6 Timer 4
D5 TBE (Transmitter Buffer Empty)
D4 RDA (Read Data Available)

D3 Timer 3
D2 EOJ (End of Job)
D1 Timer 2
D0 Timer 1

4 IN AUXILIARY DISK STATUS:

This register contains the following bits:

- D7 DRQ or RTC
- D6 always 1
- D5 X
- D4 Switch 5

- D3 Switch 1
- D2 Switch 2
- D1 Switch 3
- D0 Switch 4

D7 Data Request (DRQ) or Real-Time Clock (RTC) (jumper option)

A high in bit seven indicates that the DISK data register, PORT 33h, is requesting service. This signal is also available at ports 30h and 34h. DRQ is provided at bit seven of port 04 so that the RS7 mode of the UART may be selected (see description of RS7; bit 2 of port 2) if interrupt-driven disk routines are required. When shipped, the 64FDC does **not** have the enabling jumper inserted.

When the real-time clock (RTC) jumper is inserted, D7 will be connected to a 512-millisecond square wave. This signal can be used to generate an interrupt when the RS7 mode of the UART is selected.

D6 Seek In Progress

A high in bit six indicates that the voice-coil motor in the currently selected drive is in motion.

D5 Not assigned

D4-D0 Sense Switches

Bits D3 through D0 reflect the state of switch sections 1-4. Bit D4 indicates the state of switch section 5. A zero bit corresponds to a switch being ON.

04 OUT AUXILIARY DISK COMMAND:

This register contains the data which drives the parallel-output buffers. The options which pertain to the Cromemco 299B disk drive follow.

D7 X
D6 X
D5 -DRIVE SELECT OVERRIDE*
D4 X

D3 X
D2 -CONTROL OUT*
D1 -SIDE SELECT*
D0 X

D7 Not assigned

D6 Not assigned

D5 Drive Select Override*

A high in bit five causes no action. A low in bit five activates four drive-select outputs from the 64FDC. Normally these outputs are controlled by the 1793; this bit is provided for testing and reading drive status in multiplex applications. This bit is normally high.

D4 Not assigned

D3 Not assigned

D2 Control OUT*

A low in bit two activates the Control OUT* pad next to J1. This bit is provided for testing and is normally set high.

D1 Side Select*

A low in bit one selects the opposite side (side 1) of the currently selected diskette. A high in bit one selects the normal side of the diskette (side 0). This bit should be switched in accordance with the head-select delays of the drive used.

D0 Not assigned

05 IN Not Assigned:

Addressing this port causes no response from the 64FDC. This address is available for use by other parts of the computer system.

05 OUT TIMER 1:

This register contains the count used to start Timer 1. This count is decremented by 1 every 64 microseconds after initial loading. When the count reaches zero, bit 0 of the interrupt-request register is set and the timer disabled. Since the maximum count is 255, the longest interval is 255×64 microseconds = 16.32 milliseconds. Accuracy is plus 0 and minus 64 microseconds. Loading a count of zero sends an immediate interrupt request to the interrupt-request register. Loading a new count while the timer is counting reinitializes the timer without an interrupt request. If HBD in the command register is high, the timers will count eight times as fast.

06 IN Not Assigned:

Same as Input 05.

06 OUT TIMER 2:

Operates in the same fashion as Timer 1.

07 IN Not Assigned:

Same as Input 05.

07 OUT TIMER 3:

Operates in the same fashion as Timer 1.

08 IN Not Assigned:

Same as Input 05.

08 OUT TIMER 4:

Operates in the same fashion as Timer 1.

09 IN Not Assigned:

Same as Input 05.

09 OUT TIMER 5:

Operates in the same fashion as Timer 1.

0 IN DISK STATUS:

This register's bit assignment varies according to the last command loaded into the disk command port. There are six possible assignments:

Last Command	D7	D6	D5	D4	D3	D2	D1	D0
SEEK, STEP, or RESTORE	Not Ready	Write Protect	Head Down	Not Found	CRC Error	TK 00	Index	Busy
READ RECORD(S)	Not Ready	0	Record Type	Not Found	CRC Error	Lost Data	DRQ	Busy
WRITE RECORD(S)	Not Ready	Write Protect	0	Not Found	CRC Error	Lost Data	DRQ	Busy
READ ADDRESS	Not Ready	0	0	Not Found	CRC Error	Lost Data	DRQ	Busy
READ TRACK	Not Ready	0	0	0	0	Lost Data	DRQ	Busy
WRITE TRACK	Not Ready	Protect	0	0	0	Lost Data	DRQ	Busy

D7 Not Ready

A high in bit 7 indicates that the drive is unable to execute the command (e.g., the door is open). This bit is an inverted copy of the signal from the currently selected drive.

D6 Write Protect

During WRITE or head-moving operations, this bit is set high if the diskette in the currently selected drive has been write protected.

D5 Head Down or Record Type or Write Fault

During head-movement commands, this bit is set high when the head is down and the setting time has elapsed.

During READ RECORD(S), a low in this bit represents a Data Mark, a high in this bit represents a Deleted Data Mark. (Cromemco diskettes do not use the Deleted Data Mark.)

During WRITE operations, this bit is a copy of the WRITE FAULT input to the 1793.

D4 Not Found

A high in bit 4 indicates that the desired track and/or sector were not verified. During READ ADDRESS, a high in bit 4 indicates that no sector address field was encountered. This bit stays set until the next command.

D3 CRC Error

A high in bit 3 indicates that the internal CRC check did not agree with the diskette's CRC bytes. If bit 4 is set, the CRC error occurred in an address field; otherwise, it indicates an error in a data field.

D2 Track 00 or Lost Data

During head-movement commands, a high in bit 2 indicates that the head is positioned over TRACK 00 (farthest from the center). This signal is a copy of TK00 from the currently selected drive.

During data-transfer commands, a high in bit 2 indicates that the computer did not respond to DRQ within one byte time.

D1 Index or DRQ

During head-movement commands, a high in bit 1 indicates that the diskette in the currently selected drive is passing the INDEX or beginning of the track. This bit is a copy of IP from the drive.

During READ commands, a high in bit 2 indicates that the 64FDC has a data byte from the disk ready to be read at port 33h. This bit is reset after the data register is read.

During WRITE commands, a high in bit 2 indicates that the 64FDC needs a data byte from the computer at port 33h. This bit is reset after the data register is written.

D0 Busy

A high in bit 0 indicates that the 64FDC is executing a disk command and cannot accept a new disk command yet (except a FORCE INTERRUPT command; see description of FORCE INTERRUPT).

3. Register Descriptions

0 OUT DISK COMMAND REGISTER:

The bit assignment varies with each command. Therefore, each command will be discussed separately. A summary of the commands and bit assignments follows.

Command	D7	D6	D5	D4	D3	D2	D1	D0
RESTORE	0	0	0	0	1	V	R1	R0
SEEK	0	0	0	1	1	V	R1	R0
STEP	0	0	1	u	1	V	R1	R0
STEP IN	0	1	0	u	1	V	R1	R0
STEP OUT	0	1	1	U	1	V	R1	R0
READ RECORD(S)	1	0	0	M	S	E	C	0
WRITE RECORD(S)	1	0	1	M	S	E	C	A0
READ ADDRESS	1	1	0	0	0	1	0	0
READ TRACK	1	1	1	0	0	1	0	0
WRITE TRACK	1	1	1	1	0	1	0	0
FORCE INTERRUPT	1	1	0	1	I3	I2	I1	I0

Flags	=1	=0
V	Verify on last track	No verify
U	Update track register	No update
M	Multiple records	Single record
S	Compare for side 1	Compare for side 0
C	Enable side compare	Disable side compare
E	Enable head-load delay	Assume head is down

Fields	=0	=1	=2	=3
R1R0	3 ms 6 ms	6 ms 12 ms	10 ms 20 ms	15 ms (8" Stepping Rate) 30 ms (5" Stepping Rate)
A0	FB (DATA MARK)	F8 (DELETED DATA)		

INTERRUPT CONDITIONS	I3=1 IMMEDIATE	I2=1 INDEX	I1=1 WHEN NOT READY	I0=1 WHEN READY

Cromemco 64FDC Instruction Manual
3. Register Descriptions

<u>COMMAND</u>	<u>DESCRIPTION</u>
RESTORE	<p>Upon receipt of this command, the Track 00 (TR00) input is sampled. If TR00 is active, indicating the Read/Write head is positioned over track 0, the Track Register is loaded with zeroes and EOJ is set. If TR00 is not active, stepping pulses are issued until the TR00 input is activated. At this time, the Track Register is loaded with zeroes and EOJ is set.</p> <p>If the TR00 input does not go active after 255 stepping pulses, the 64FDC terminates operation, sets EOJ, and sets the Not Found status bit. Note that the RESTORE command is executed after a RESET. A verification operation takes place if the V flag is set.</p>
SEEK	<p>This command assumes that the Track Register contains the track number of the current position of the Read/Write head and that the Data Register contains the desired track number. The 64FDC will update the Track Register and issue stepping pulses in the appropriate direction until the contents of the Track Register are equal to the contents of the Data Register (the desired track location). A verification operation takes place if the V flag is on. EOJ is set at the completion of the command.</p>
STEP	<p>Upon receipt of this command, the 64FDC issues one stepping pulse to the disk drive. The stepping motor direction is the same as in the previous step command. After a delay determined by the RLR0 field, a verification takes place if the V flag is on. If the U flag is on, the Track Register is updated. EOJ is set at the completion of the command.</p>
STEP IN	<p>Upon receipt of this command, the 64FDC issues one stepping pulse in the direction towards the center of the diskette. If the U flag is on, the Track Register is incremented by one. After a delay determined by the RLR0 field, a verification takes place if the V flag is on. EOJ is set at the completion of the command.</p>
STEP OUT	<p>Upon receipt of this command, the 64FDC issues one stepping pulse in the direction towards track 0. If the U flag is on, the Track Register is decremented by one. After a delay</p>

3. Register Descriptions

determined by the R1R0 field, a verification takes place if the V flag is on. EOJ is set at the completion of the command.

These five commands have an optional verification flag. During verification, the first-encountered ID field is read off the disk. The track address of the ID field is then compared to the Track Register; if there is a match and a valid ID CRC, the verification is complete, EOJ is set, and the BUSY status bit is reset. If there is not a match but there is a valid ID CRC, then EOJ is set, the Not Found status bit (Status bit 4) is set, and the BUSY status bit is reset. If there is a match but not a valid CRC, then the CRC Error status bit is set (Status bit 3), and the next-encountered ID field is read from the disk for the verification operation. If an ID field with a valid CRC cannot be found after four revolutions of the disk, the 64FDC terminates the operation, sets EOJ, and sets the Not Found bit in the status register.

The STEP, STEP-IN, and STEP-OUT commands contain an UPDATE flag (U). When U = 1, the Track Register is updated by one for each step. When U = 0, the Track Register is not updated.

READ RECORD(S)

Upon receipt of the Read command the drive is selected and the BUSY status bit is set. When an ID field is encountered that has the correct side number (if side compare is enabled, s=1), correct track number, correct sector number, and correct CRC, the data field is presented to the computer. The Data Address Mark of the data field must be found within 28 bytes of the correct field; if not, the Not Found status bit is set and the operation is terminated. When the first character or byte of the data field has been shifted, DRQ is generated. When the next byte is accumulated, another DRQ is generated. If the computer has not read the previous contents of the Data Register before a new character is transferred, that character is lost and the Lost Data status bit is set. This sequence continues until the complete data field has been input to the computer. If there is a CRC error at the end of the data field, the CRC Error status bit is set and the command is terminated (even if it is a multiple-record command). If five index pulses go by without finding the proper ID field, the Not Found bit and EOJ are set.

Cromemco 64FDC Instruction Manual
3. Register Descriptions

At the end of the Read operation, the type of Data Address Mark encountered in the data field is recorded in the Status Register (Bit 5) as shown below:

<u>Status</u> <u>Bit 5</u>	<u>Data AM</u> <u>(HEX)</u>
0	Data Mark
1	Deleted Data Mark

Cromemco diskettes never use the Deleted Data Mark.

WRITE RECORD(S)

Upon receipt of the Write command, the drive is selected and the BUSY status bit is set. When an ID field is encountered that has the correct side number (if the side compare is enabled, s=1), the correct track number, correct sector number, and correct CRC, a DRQ is generated. The 64FDC counts off 11 bytes in single density and 22 bytes in double density from the CRC field and the Write Gate (WG) output is made active if the DRQ is serviced (i.e., the Data Register has been loaded by the computer). If DRQ has not been serviced, the command is terminated and the Lost Data status bit is set. If this DRQ has been serviced, six bytes of zeroes in single density and 12 bytes in double density are written on the disk. The Data Address Mark is then written on the disk as determined by the A0 field of the Write Record(s) command as shown below. Refer to the Disk Command Register for additional information.

<u>A0</u>	<u>DATA MARK</u> <u>(HEX)</u>
0	Data Mark
1	Deleted Data Mark

The 64FDC then writes the data field and generates DRQ's to the computer. If the DRQ is not serviced in time for continuous writing, the Lost Data status bit is set and a byte of zeroes is written on the disk. The command is not terminated. After the last

Cromemco 64FDC Instruction Manual
 3. Register Descriptions

data byte has been written on the disk, the two-byte CRC is computed internally and written on the disk, followed by one byte gap of logic ones.

The two commands READ RECORD(S) and WRITE RECORD(S) determine the sector size by examining the Sector Length byte in the ID field. The numbers of bytes in the data field (sector) is then 128×2^n where $n=0,1,2,3$.

<u>Sector Length Field (hex)</u>	<u>Number of bytes in sector (decimal)</u>
00	128
01	256
02	512
03	1024

These two commands also contain a flag, **M**, which determines if multiple records (sectors) are to be read or written, depending upon the command. If $M = 0$, a single sector is read or written and EOJ is set at the completion of the command. If $M = 1$, multiple records are read or written with the sector register internally updated so that an address verification can occur on the next record. The 64FDC will continue to read or write multiple records and update the sector register until the sector register exceeds the number of sectors on the track. If five index pulses go by without finding the proper ID field, the NOT FOUND bit and EOJ are set.

READ ADDRESS

Upon receipt of the Read Address command, the head is loaded and the BUSY status bit is set. The next-encountered ID field is then read in from the disk and the six data bytes of the ID field are assembled. DRQ is generated for each byte. The six bytes of the ID field are:

	<u>TRACK ADDR</u>	<u>SIDE NUMBER</u>	<u>SECTOR ADDR</u>	<u>SECTOR LENGTH</u>	<u>CRC 1</u>	<u>CRC 2</u>
Byte	1	2	3	4	5	6

Although the CRC characters are transferred to the computer, the 64FDC checks for validity and the CRC Error status bit is set if there is a CRC error. The Track Address of the ID field is written into the sector register.

This permits the system to verify that the head is where the controller thinks it is without transferring data. At the end of the operation, EOJ is set and the BUSY status bit is reset.

READ TRACK

Upon receipt of the Read Track command, the head is loaded and the BUSY status bit is set. Reading starts with the leading edge of the first-encountered index mark and continues until the next index pulse. As each byte is assembled, it is transferred to the Data Register and the Data Request is generated for each byte. No CRC checking is performed. Gaps are included in the input data stream. The accumulation of bytes is synchronized to each Address Mark encountered. Upon completion of the command, EOJ is set.

WRITE TRACK

Upon receipt of the Write Track command, the head is loaded and the BUSY status bit is set. Writing starts with the leading edge of the first-encountered index pulse and continues until the next index pulse, at which time EOJ is set. The Data Request is activated immediately upon receiving the command, but writing will not start until after the first byte has been loaded into the Data Register. If the Data Register has not been loaded by the time the index pulse is encountered, the operation is terminated, making the device Not Busy, setting the Lost Data status bit, and setting EOJ. If a byte is not present in the Data Register when needed, a byte of zeroes is substituted. Address Marks and CRC characters are written on the disk by detecting certain data-byte patterns in the outgoing data stream as shown in the table below. The CRC generator is initialized when any data byte from F8 to FE is about to be written in single density, or by F5 in double density.

CONTROL BYTES FOR INITIALIZATION

DATA PATTERN IN DR (HEX)	FD1793 INTERPRETATION IN FM (DDEN\=1)	FD1793 INTERPRETATION IN MFM (DDEN\=0)
00 through F4	Write 00 through F4 with Clk=FF	Write 00 through F4, in MFM
F5	Not Allowed	Write A1* in MFM, Preset CRC
F6	Not Allowed	Write C2** in MFM
F7	Generate 2 CRC bytes	Generate 2 CRC bytes
F8 through FB	Write F8 through FB, clk=C7, Preset CRC	Write F8 through FB, in MFM
FC	Write FC with Clk=D7	Write FC in MFM
FD	Write FD with Clk=FF	Write FD in MFM
FE	Write FE, Clk=C7, Preset CRC	Write FE in MFM
FF	Write FF with Clk=FF	Write FF in MFM
*Missing clock transition between bits 4 and 5 **Missing clock transition between bits 3 and 4		

Note that one F7 pattern generates 2 CRC characters.

FORCE INTERRUPT

The command can be loaded into the command register at any time. If there is a current command under execution (BUSY status bit set), the command will be terminated and EOJ will be set when the condition specified in the I0 through I3 field is detected. The interrupt conditions are shown below:

- I0 = Not-Ready-To-Ready Transition
- I1 = Ready-To-Not-Ready Transition
- I2 = Every Index Pulse
- I3 = Immediate Interrupt

If I3 - I0 = 0, the command will be terminated but EOJ will not be set. The FORCE INTERRUPT commands above must be cleared in this manner before the 64FDC is given its next command.

31 IN/OUT TRACK REGISTER:

This register holds the track number of the current Read/Write head position. It is incremented by one every time the head is stepped in (towards track 76) and decremented by one when the head is stepped out (towards track 00). The contents of the register are compared with the recorded track number in the ID field during disk Read, Write, and Verify operations. This register should not be loaded when the 64FDC is busy.

32 IN/OUT SECTOR REGISTER:

This register holds the address of the desired sector position. The contents of the register are compared with the recorded sector number in the ID field during disk Read or Write operations. This register should not be loaded when the device is busy.

33 IN/OUT DATA REGISTER:

This register is used as a holding register during Disk Read and Write operations. In Disk Read operations, the assembled data byte is transferred in parallel to the Data Register from the Data Shift Register. In Disk Write operations, information is transferred in parallel from the Data Register to the Data Shift Register.

In Seek operations the desired track number is output to the Data Register.

4 IN DISK FLAGS:

This port provides four signals.

D7 DRQ
D6 BOOT*
D5 SELECT REQUEST
D4 INHIBIT INIT*

D3 MOTOR ON
D2 MOTOR TIMEOUT
D1 AUTOWAIT TIMEOUT
D0 EQJ

D7 Data Request (DRQ)

A high in bit 7 indicates that the 64FDC has a byte from the disk or needs a byte for the disk according to the current operation.

D6 Boot*

A low in bit 6 indicates that jumper location 3 is set to BOOT*. A high in bit 6 indicates that jumper location 3 is set to MON.

D5 Select Request

A high in bit 5 indicates that the 1793 is requesting drive select. A low in bit 5 indicates that the 1793 is not requesting drive select.

D4 Inhibit Init*

A low in bit 4 indicates that jumper location 4, INHIBIT INIT*, is jumpered. A high in bit 4 indicates that jumper location 4 is not jumpered.

D3 Motor On

A high in bit three indicates that the 64FDC is requesting the drive motors to turn on. A low in bit three indicates that the 64FDC is no longer requesting the drive motors to turn.

D2 Motor Timeout

A high in bit 2 indicates that the motors have been turned off. The motors will turn off about 8 seconds after the last disk operation. A low in bit 2 indicates that the motors have not been turned off.

D1 Auto Wait Timeout

A high in bit 1 indicates that the Auto Wait circuit has been turned off by the timer. This will occur about 4 seconds after Auto Wait is turned on. A low in bit 1 indicates that the Auto Wait circuit has not timed out.

D0 End of Job (EOJ)

A high in bit 0 indicates that the command has finished (end of job). This bit is reset when the Status register is read.

34 OUT DISK CONTROL:

D7 AUTO WAIT
D6 DOUBLE DENSITY
D5 MOTOR ON
D4 MAXI

D3 DS4
D2 DS3
D1 DS2
D0 DS1

D7 Auto Wait

A high in bit seven puts the 64FDC into Auto Wait mode which means that subsequent reading of Input port 34h will hold the CPU in a WAIT state until one of four things happens:

1. The 64FDC issues a DRQ (this is the normal use of the AUTO WAIT).
2. The 64FDC issues EOJ. This terminates the AUTO WAIT condition (the normal method of termination).
3. There is a hardware RESET.
4. The AUTO WAIT timer goes off (abnormal termination).

D6 Double Density

A high in bit six conditions the 64FDC to Read/Write/Format double-density diskettes. A low in bit six conditions the 64FDC for single density.

D5 Motor On

A high in bit 5 activates the MOTOR ON signal to **all** disk drives and resets the motor timer. A low in bit 5 deactivates the MOTOR ON signal to all disk drives. The timer deactivates the motors automatically after about 8 seconds. This bit must be set high to access the disk.

This bit is set by RESET.

D4 Maxi

A high in bit 4 conditions the 64FDC for an 8-inch disk drive (Maxi). A low in bit 4 conditions the 64FDC for a 5-inch disk drive (Mini).

This bit is set by RESET.

D3-D0 Drive Select

A high in bits 3 through 0 selects the corresponding disk drive for all further operations. Only one drive should be selected at a given time.

RESET deselects all drives.

40 IN Not Assigned.

40 OUT **BANK SELECT:**

Outputting any byte to port 40h will disable the 4K ROM on the 64FDC if jumper location 2 is jumpered. The ROM may be reenabled by RESET.

Chapter 4

INTERFACE CHARACTERISTICS

The 64FDC appears on the S-100 bus as a 32K memory card and 15 I/O ports. The 64FDC is capable of generating interrupts and responding on a prioritized basis to the interrupt-acknowledge cycle. Data exchange for the disk and serial I/O is programmed, not via direct memory access (DMA). This requires a minimum CPU speed of 4MHz and no memory wait states (at 4MHz) in the buffer memory.

The Bootstrap/Monitor ROM is addressed at C000-CFFFh. This address may be changed by cutting traces and inserting jumpers. Hold Acknowledge will temporarily disable the ROM. At 4MHz, the 64FDC inserts one wait state. There are no wait states at 2MHz. When location one is jumpered (see Chapter 1), the ROM is defeated and the 64FDC occupies no address space in memory. When location 2 is jumpered, the ROM is disabled as soon as a byte (any byte) is written to output port 40h, the bank select port. The ROM is reenabled by a hardware RESET.

The serial I/O channel requires 10 I/O addresses. CDOS requires these to start at I/O address 00, the way the 64FDC is shipped. The serial I/O channel is asynchronous because it uses the onboard clock. When one of the serial I/O channel's ports is addressed by the CPU, the 64FDC pulls down PRDY and holds it down until the 64FDC synchronizes with the CPU (up to 1 usec.)

The disk I/O ports are asynchronous. CDOS assumes a base address of 30h. There is one case in which the 64FDC will create wait states for the disk I/O ports:

If the Auto Wait mode has been selected an indefinite number of waits will be added to read or write operations on port 34h.

The CPU will stay in a WAIT state until the 64FDC issues a Data Request or an End of Job signal (or until there is a hardware RESET).

SERIAL CHANNEL - INTERFACE CHARACTERISTICS

The 64FDC provides both RS-232 and 20-mA current loop interface. For RS-232 connect three wires from your terminal as follows:

64FDC	RS-232 terminal
<u>J4</u>	<u>(e.g., CRT)</u>
pin 7	Signal ground (not chassis)
pin 3	Receiver data (for display)
pin 2	Transmitter data (keyboard)

Some terminals may require additional modem control signals. With the Cromemco 3100, 3101, and 3102 the three signals given above are the only connections necessary. With other terminals, the 64FDC will provide primitive modem control signals in the usual location. Note that the 64FDC is acting as the data communications equipment (modem). The following signals will be held continuously in the on condition.

64FDC	RS-232 terminal
<u>J4</u>	<u>RS-232 terminal</u>
pin 5	clear to send
pin 6	data set ready
pin 8	data carrier detect

For 20-mA teletype interface, solder jumpers into the five locations provided below J4. Make the following connections:

64FDC	ASR33
<u>J4</u>	<u>Terminal Strip "BL"*</u>
pin 25	terminal 6 (printer current out)
pin 24	terminal 3 (keyboard current out)
pin 23	terminal 7 (printer current in)
pin 17	terminal 4 (keyboard current in)

*Caution: 120 VAC is also present on terminal strip BL at terminals 1 and 2.

8" AND 5" DISK DRIVE - INTERFACE CHARACTERISTICS

The 64FDC drives J2 and J3 (the disk drive signal cable connectors) in parallel through separate sets of TTL bus drivers. The signal cables should be terminated (150-ohm resistors to +5 volts) at the end of the cable only. If more than one disk drive **per cable** is used, only the last drive on the cable should use pullups. Signals from the drives back to the controller are terminated on the 64FDC with 150-ohm pullups.

OUTPUTS FROM THE 64FDC: (All active low)

DS1* These are four drive-select signals.
DS2* When a drive-select signal is active
DS3* the selected drive should enable its
DS4* data and status drivers and load the
read/write head.

All other drives should ignore signals until selected.

STEP* This line goes active low for 16 microseconds to move the head of the selected drive in the direction specified by output DIRC*. For multiple steps, the stepping rate is determined by the format of the command given to the 64FDC and will be 3, 6, 10, or 15 milliseconds per step for large floppies or 6, 12, 20, or 30 milliseconds per step for small floppies. The 64FDC will wait one stepping period after the last step for the head to settle before attempting to read or write the diskette.

DIRC* When this line is asserted (low), pulses on the STEP line should cause the head of the selected drive to advance one track per step towards the center of the diskette. If DIRC* is high, pulses on the STEP* line should cause the head of the selected drive to retreat one track per step towards the outer edge of the diskette (towards Track 00).

MOTOR OFF* This signal turns off the motors of all 8" drives when low. When it is high it turns on the motors of all 8" drives which are so equipped.

MOTOR ON*

This signal turns on the motors of all 5" drives when low. When it is high it turns off the motors of all 5" drives which are so equipped.

WRITE GATE*

This signal goes low to enable diskette write operations.

WRITE DATA*

This signal contains the intermingled clock and data pulses to be written on the diskette. Pulse width varies from 250 nanoseconds for 8" double density to 1 microsecond for 5" single density.

WRITE CURRENT SWITCH*

This signal instructs the drive to use a lower write current on inside tracks (44 and in).

INPUTS TO THE 64FDC

INDEX*

This line should go low for at least 10 useconds once per revolution of the diskette.

TRACK 00*

This signal should go low and stay low while the selected drive is on track 00, the outermost track.

READY*

This signal should be low when the disk drive is operable (i.e. door is closed, motor speed up, etc.) The 64FDC will always initiate a command regardless of the state of READY; the purpose of the signal is for detecting disk change operations using the Force Interrupt command.

WRITE PROTECT*

This signal goes low if a write-protected diskette is in the currently selected drive.

READ DATA*

This signal is composite clock and data pulses from the disk drive. The line pulse low for each flux reversal on the surface of the diskette.

Chapter 5

INITIAL SETUP

TANDON TM848

In order to implement the motor control logic on the 64FDC it is necessary to install the M2 jumper on the two posts immediately above Plug 6 (see Figure 5-1).

Drive Select is set up with a jumper plug on one of the four sets of posts directly above the stepper motor (see Figure 5-1). Here are the jumper positions.

Drive A	-	DS1
Drive B	-	DS2
Drive C	-	DS3
Drive D	-	DS4

For a drive with a revision level of H or higher, the above jumpers are the only modifications needed on a drive as it was made by Tandon. On a Revision G or earlier drive, make the following component changes.

R126	-	20 kohm
R128	-	20 kohm
C59	-	0.47 uF
C60	-	33 uF

For a drive earlier than Revision G, or any used drive, verify the jumper options with an ohmmeter or continuity tester according to the table given below. None of the locations on the shunt at U3 should be cut. Some of the option pads on the early drives are connected with a printed-circuit trace on the solder side of the board.

Cromemco 64FDC Instruction Manual
 5. Initial Setup

OPTION	TRACE DESIGNATOR	INSTALLED
Side Select Options using Drive Select In Use, Head Load Radial Ready Ready, Modified Radial Index In Use, Alternate Output Pad Diskette Lever Lock Latch Option Disk Change Two-sided Diskette Installed Stepper Power from Drive Select Head Load Alternate Output Pad Inhibit Write When Write-Protected Allow Write When Write-Protected Head-side Select Options Spindle Motor Control Options* Motor Control Select	1B-4B Y RR RM RI D DL DC 2S DS C WP NP S1-S3 M1-M4 MC1-MC4	NO NO YES NO YES NO NO YES YES NO YES NO NO YES NO S2 M1-M3 MC1
*This is the only option set differently from the way the drive is shipped.		

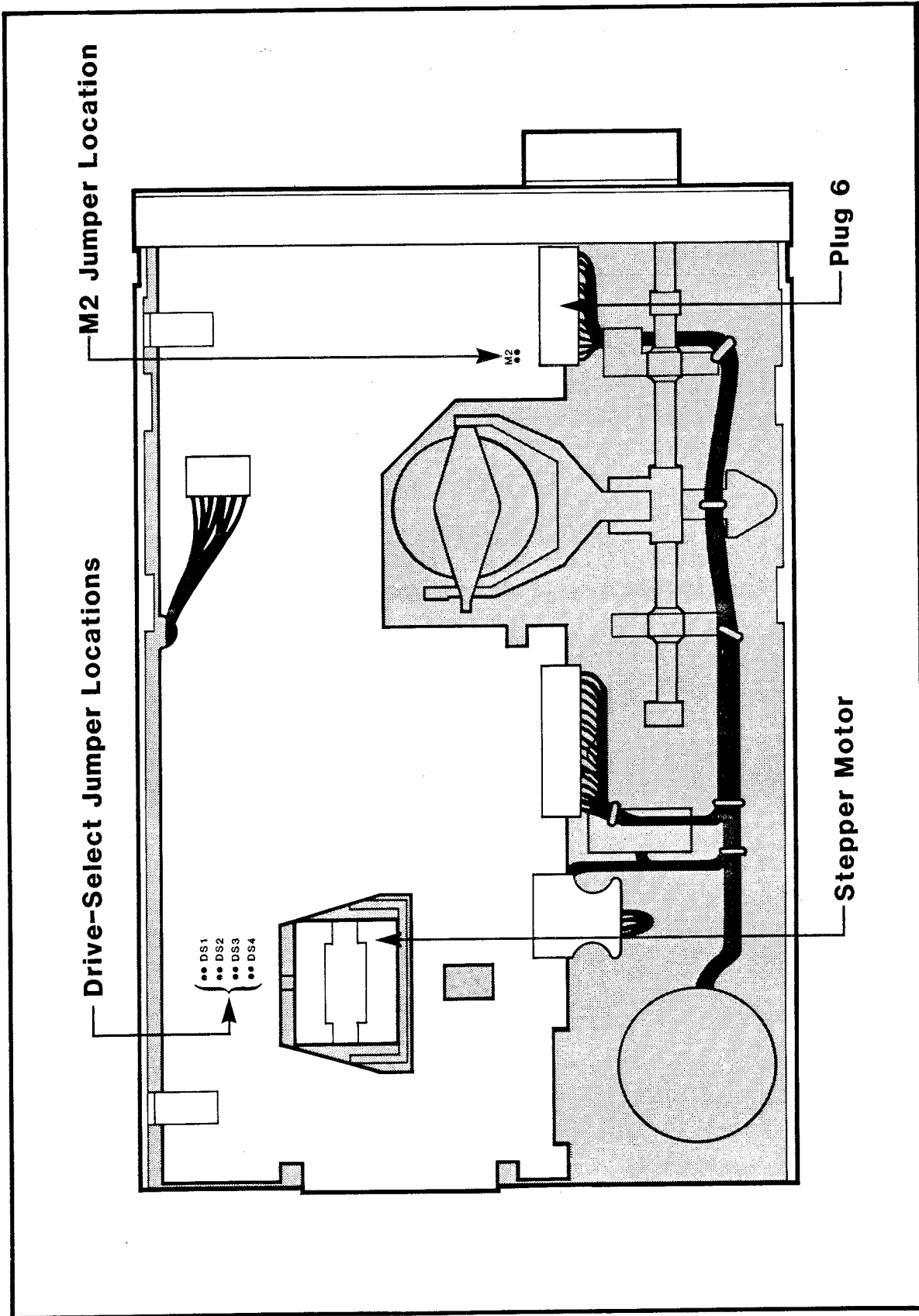

Figure 5-1: TM848 SETUP

TANDON TM100

Locate the package of jumper straps (shunt 1E) just above the pc board edge connector. The jumper positions used for Drive Select are:

- Drive A - jumper pin 2 to 15 only
- Drive B - jumper pin 3 to 14 only
- Drive C - jumper pin 4 to 13 only
- Drive D - jumper pin 5 to 12 only

In older drives, it may be necessary to jumper from the land labelled 6 beside the 34-pin connector J1 to the land beside TP5. This provides continuity for the Drive Select signal for Drive D, which enables it to be jumpered through the shunt at pins 5 and 12.

Cromemco recommends that only the drive select required be enabled and that all other connections **not** be jumpered. In a system with more than one small drive, remove the terminator packs from all but one of them. The drive with a terminator pack should be the one at the end of the interface cable. The drawing below shows the location of the terminator pack next to the edge connector.

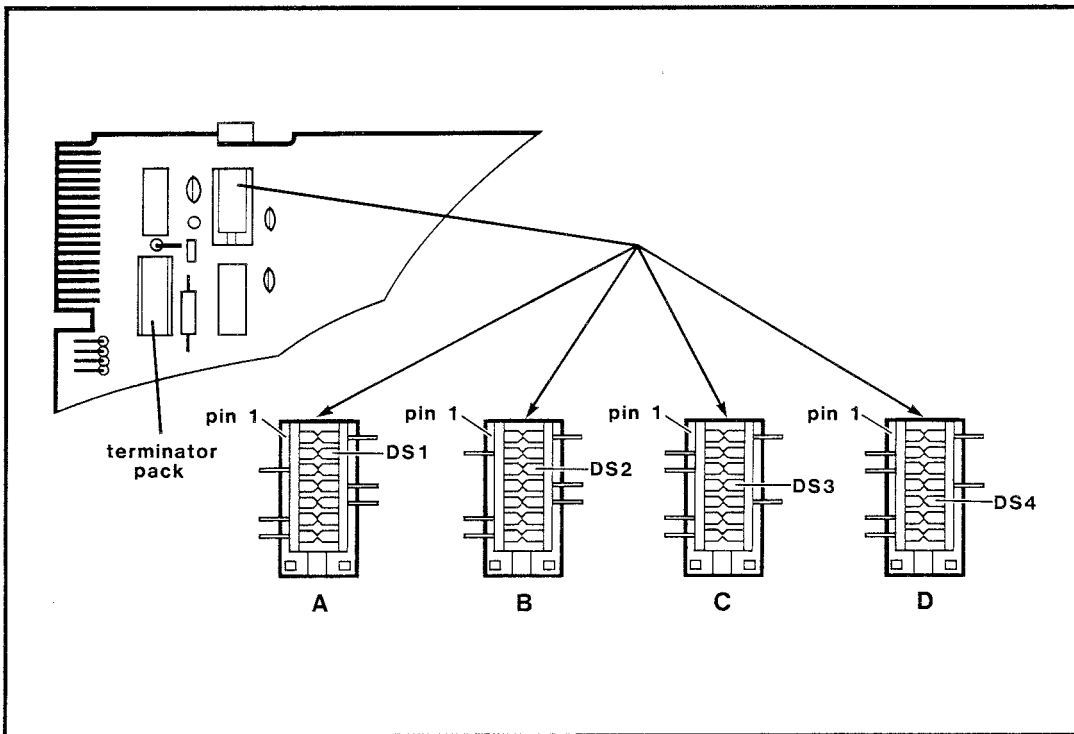

Figure 5-2: TM100 SETUP

Chapter 6

THEORY OF OPERATION

POWER SUPPLIES

The unregulated bus power lines are converted to regulated supplies of +5, -5, and +12 volts by ICs 45, 18, and 33 respectively. The 64FDC requires 1.0 A at +8 unregulated, 0.100 A at +18 unregulated, and 0.100 A at -18 unregulated.

ADDRESS DECODE

The 64FDC decodes address and status signals on the bus to find the following conditions:

1. Memory-read cycles in the address range 8000-FFFFh.
2. Input/Output references in the address range 00-09h.
3. Input/Output references in the address range 30-34h.
4. Output references to port 40h.

In case 2, the address decoding is done in two stages. First, the base address is decoded by IC37, then the offset is determined by IC36. Pin 9 of IC37 goes low for addresses in the range of 00-09h.

DATA BUS

The 64FDC has a three-state, bi-directional internal data bus. It is coupled to the Data In and Data Out buses on the S-100 bus through latch ICs 49 and 51. There are four cases of operation determined by the particular 64FDC function being addressed.

Input/Output references in the range 00-09h: When the TMS5501 IC27 is addressed, the 64FDC emulates an 8080 I/O cycle (M3). This is necessary to generate strobed status bits and to insure the correct read/write timing.

The cycle begins when IC36P5 goes low, presenting a high to the JK inputs of the first section of IC31. This section of IC31 is clocked by the falling edge of internal phase 2, and shifts a high level to IC31P5. This high level generates an internal SYNC pulse at IC42P13. This internal SYNC pulse enables status strobe drivers IC35P6 and IC35P3 (Write Output and Interrupt Acknowledge respectively), disables the incoming bus drivers, and triggers the SYNC pin of the TMS5501. SYNC is terminated by the rising edge of phase 2, which clocks the next section of IC31 and presents a high level at IC31P12. During this period, the TMS5501 internally arranges data paths while the 64FDC idles. When phase 2 falls again, IC53P8 goes low, which opens the gate of the output latch IC51, admitting the data from the TMS5501. Multiplexer IC50 passes the data straight through **except** when the 64FDC is in the process of reading the serial status port (Input port 00). In this case IC36P7 goes low, causing the multiplexer to switch D7 and D6 with D4 and D3 (producing the status bit assignment detailed in Chapter 3). The cycle finally terminates when phase 2 rises again, shifting a high level to IC31P16.

WAIT-STATE GENERATOR

The wait-state generator, IC8P7, passes on wait requests when enabled by IC22. There are three enabling conditions:

1. 4MHz ROM access.
2. Disk references with Auto Wait mode selected.
3. Any reference to the TMS5501 (ports 00-09).

There are three sources of wait request:

1. PSYNC.
2. Ready from wait IC20P12.
3. Ready from TMS5501 (IC20P10).

The coincidence of an enabling condition and a wait request stops the processor in mid-cycle.

CLOCKS

The 64FDC has an 8.000-MHz onboard crystal clock which controls all internal board timing. IC29 conditions the clock for the TMS5501 and FD1793. 2-MHz phase 1 and phase 2 signals are generated at IC41P3 and IC30P4 respectively. A 1-MHz timing signal is generated at IC29P15 and a switchable 2- or 1-MHz clock is generated at IC29P16 (controlled by the maxi/mini signal at IC41P13).

BANK SELECT

The onboard ROM may be disabled through output port 40h if jumper location 2 (RES) is jumpered. In this case, the ROM is deselected permanently after the first output to port 40h clocks flip-flop IC19 and forces IC19P5 low. This forces the memory address decoder IC47P9 high, deselecting the ROM. The ROM may be reenabled by a hardware RESET signal, which sets IC19P5 high again.

TMS5501 INTERFACES

IC12 requires 12-volt clock levels at the phase 1 and phase 2 inputs. These are supplied by active pullups Q7 and Q8 which, when triggered by a falling edge at the input of open collector inverter package IC15, switch on briefly to pull the inverter outputs up to 12 volts.

The serial output IC27P40 is inverted and shifted from TTL levels to ± 12 volts by IC16. IC15P12 provides an open collector current sink for current loops.

The serial input IC27P5 is controlled by IC44P3.

FD1793-1 INTERFACES

All signals from the drives are TTL-buffered and have 150-ohm pullups. Maxi and mini signals are wire-ANDed at the pullup side of the buffers. READY is disabled and pulled high when the mini is selected.

Signals to the drives from the 1793 are TTL-buffered with separate buffers for mini and maxi connectors. The HLD (head load) output does not go directly to the drives, but rather enables the drive-select lines through IC9P1. Thus, the actual drive-select signal to

the drive is the coincidence of a latched drive selection (done at port 34h) and HLD from the 1793.

Signals DRQ, HLD, and INTRQ (or EOJ) are available at input port 34h (IC28). Various control signals are assigned to output port 34h and are latched by ICs 10 and 4.

WRITE PRECOMPENSATION

Write Precompensation is accomplished by IC30, a PAL which, when programmed by Cromemco, becomes a 74946. There are two sections to IC30. Precomp is switched on and off by a multiplexer. When Precomp is turned off, the PAL outputs over pin 19 exactly what it sees on its WD input at pin 5. For an eight-inch drive, inside track 43, and operating in double density, the output at IC30P19 is generated by a state machine. The output pulse is delayed from the input by a number of 8-MHz clock cycles determined by the early and late lines at pins 8 and 9.

PRIORITY CHAIN

The 64FDC includes a ripple priority circuit which will defeat the interrupt-acknowledge cycle if Priority In* is held low. If the 64FDC is allowed to perform the interrupt acknowledge, it will pull down its Priority Out* line to signal others in the chain not to respond. This chain is compatible with the Cromemco TU-ART.

AUTO WAIT

An output to port 34 clocks D7 into IC4P2. When the Auto Wait is turned on, a read of port 34 will force IC22P6 high, which puts the system into an extended wait state.

The wait state can end for one of four reasons. IC4P5 can be forced low by a system reset or by an interrupt request from the 1793. The Data Request output from the 1793 can raise IC22P5, forcing IC22P6 low. The Auto Wait timeout can pull IC22P2 high.

When the Auto Wait is turned off, shift register IC7 is held clear by IC4P5. Turning Auto Wait on permits IC7 to clock a one from the serial input to the last

parallel output. It clocks approximately twice per second, so after 8 clock cycles or four seconds, IC7 P13 goes high, forcing IC22P6 low to end the wait state.

MOTOR TIMER

IC6 is an eight-stage parallel load shift register clocking every four seconds. An output to port 34 causes it to load asynchronously. The first five stages load with logic zero. The final three stages are loaded with data-bit 5, the MOTOR ON bit. The final stage at IC6P9 drives the motor control lines on the interface through two buffers in IC11. If IC7 is not reloaded before a logic zero clocks through to the output, the drive motors will automatically turn off.

PHASE-LOCKED LOOP

The 64FDC uses a Phase-Locked Loop (PLL) to generate a square wave READ CLOCK (RCLK) for the 1793-B02 disk controller IC. The IC uses RCLK to separate clock bits from data bits and to shift the internal data-shift register. The signal RCLK is synchronized to the data so that the data pulses from the drive occur close to the middle of the high or low portions of the square wave. If the data rate is different from the frequency of RCLK, the PLL adjusts itself via error feedback. This allows the 64FDC to compensate for minor variations in motor speed, etc.

When the 64FDC is idling, the PLL generates a free-running RCLK which is close to the normally expected data rate. This frequency depends upon the size and density of the diskette as specified by the control bits MAXI and DDEN of port 34H. RCLK is actually generated by a divide-by-two flip-flop which is clocked by the sharp spikes used to reset the PLL's sawtooth oscillator. The following table shows the resulting frequencies:

MAXI	DDEN	RCLK	SAWTOOTH
1	1	500 KHz 2 usec	1 MHz 1 usec
1	0	250 KHz 4 usec	500 KHz 2 usec
0	1	250 KHz 4 usec	500 KHz 2 usec
0	0	125 KHz 8 usec	250 KHz 4 usec

The sawtooth is formed by discharging the timing capacitor, C5, and the trimmer, C2, through current-sink transistor Q3 until the buffered sawtooth voltage is less than the reference value at pin 3 of the comparator, IC2. Then the comparator switches on, causing the output of inverter IC24P4 to go low and turn on the reset switch, transistor Q2. This resets the timing capacitor to zero charge, clocks the RCLK flip-flop, and switches the comparator off to begin a new cycle.

The frequency of the free-running sawtooth is controlled by the collector current of Q3. At the maximum frequency, 1 MHz, this current is set by the voltage applied to the 499-ohm resistor from the emitter of Q3 to ground. The voltage is essentially the same as at the noninverting input of the opamp, IC1P5, since the base-emitter voltage drop of Q3 is compensated for by feedback to the opamp. The current flowing through the resistor is supplied by the emitter of Q3, and, assuming negligible base current, this same current flows into the collector of Q3 from the timing capacitor. Since the voltage across the 499-ohm resistor is held to .6 volts by the resistive divider at IC1P5, 1.2 mA flows through Q3 when the sawtooth is running at 1 MHz.

The sawtooth frequency is lowered by reducing the current in the collector of Q3. To go from 1 MHz to 500 KHz, the collector current is reduced from 1200 uAmps to 600 uAmps. The reduction occurs when current from switch IC3P10 is allowed to flow through the 499-ohm resistor to ground. If 600 uAmps are supplied through the switch, Q3's emitter need supply only 600 uAmps to bring the total up to 1200 uAmps (recall that the voltage across the resistor is fixed to be .6 volt by the opamp, and this requires a total current of 1200 uAmps). Thus the collector current in Q3 is reduced by the amount of current supplied through the switch.

The lowest frequency is obtained by injecting 900 uAmps through the switch IC3P10. The current through the switch is controlled by a current source made up of an opamp and transistor, with switched resistors in the emitter of the transistor. The opamp establishes a voltage at the emitter of Q1 which is equal to the voltage at IC1P3. The current flowing out of the collector of Q1 is equal to the voltage drop across the emitter resistor (half the analog supply voltage) divided by the selected emitter resistance.

The following table shows the relationship between currents:

Total Current through R11	Q3 Collector Current	Switch Current	Sawtooth Frequency
1200	1200	0	1 MHz
1200	600	600	500 KHz
1200	300	900	250 KHz

When a signal is applied to the PLL from the disk, the voltage at the opamp, IC1P5, is adjusted in the following manner, so that the sawtooth frequency matches the data rate. Each incoming data pulse fires a pulse-shortening one-shot, IC5P12, which briefly strobes the sample-and-hold switch from IC3P4 and P9 to P3 and P8. This switch stores the voltage of the sawtooth on capacitor C22 at the end of the strobe pulse. If the data frequency and phase are matched to the PLL, each pulse will occur at the middle of the sawtooth. If the data pulse occurs early, it will strobe the sawtooth at a higher voltage than normal. This higher voltage causes the voltage at P5 of the opamp IC1 to rise, which increases the current through Q3 and speeds up the sawtooth. Conversely, if the data pulse occurs later than normal, it will lower the voltage at the opamp and slow down the sawtooth. The rate of change is controlled by the loop filter, RN1P4 to P5 and C10, the sensitivity of the sawtooth oscillator and sample-and-hold; the rate is set for rapid lockup. The PLL has been designed for rapid and stable lockup in all modes because the natural frequency and damping factor of the control loop are independent of the sawtooth frequency.

MODE 2 INTERRUPT ACKNOWLEDGE

When the 64FDC is used with a Z80 CPU, it may be desirable to use the interrupt structure known as **Mode 2**. In this mode, the interrupting device supplies a one-byte vector, rather than an instruction, to the CPU. The vector is appended to the Interrupt page, or I register in the Z80, and the resulting 16-bit value points to a location in memory which stores a two-byte address for the interrupt service routine.

Normally, the 64FDC supplies the opcode of a restart instruction when it is responding to an Interrupt Acknowledge cycle. In mode 0 (8080-compatible mode), these opcodes, C7, CF, D7, DF, ..., F7, and FF are interpreted by the Z80 as RST 0, RST 8, and so on. In mode 2, the Z80 interprets these opcodes as vectors, as described above. For example, if the I register is set to 01 and the 64FDC supplies a vector of D7, the Z80 will read locations 01D7 and 01D8 to get the pointer to the interrupt service routine. (In mode 0 the Z80 would have executed RST 10).

Since these opcodes are odd (i.e., bit zero is a one), they are mismatched to the normal form of mode 2 vectors, which are even. Recalling that these vectors form the low byte of a memory pointer, one can see that it is possible to get the most vectors per I-page if the vectors start at 00 and work up. This is why the normal form of mode 2 vectors is even.

The 64FDC can be converted to mode 2 (even) vectors by inserting a jumper which forces bit zero of the vectors to be zero. Once this jumper is inserted, the possible Interrupt Acknowledge vectors will be C6, CE, D6, DE, ..., F6, and FE. A 64FDC that has this jumper inserted is no longer compatible with the mode 0 (8080-compatible) interrupt structure. Also, the interrupt address register will not be affected and thus will still contain the restart op codes.

REAL-TIME CLOCK

The 64FDC offers a highly accurate, 524.29-millisecond, real-time clock interrupt which may be selected as an interrupt source through a jumper wire (refer to Figure 3-1). If selected, interrupts will be generated when the 5501 is programmed to disable Timer 5 interrupts and enable the DRQ/RTC interrupt. The mask register must also be set properly.

• **Appendix A**

TUNING THE DATA SEPARATOR

This procedure **MUST NOT BE PERFORMED BY THE USER**. Special test equipment must be used by trained personnel to make this adjustment. There is **no way** to tune the data separator without this equipment.

This adjustment requires a frequency counter. Nothing else is accurate enough to obtain reliable double-density operation at the inner tracks. Connect the probe to pin 8 of IC4, and 74LS74. Reset the system and, if necessary, use the ESCAPE key to abort the boot. Adjust the trimmer capacitor near IC4 at the edge of the board for a frequency of 500 ± 1 KHz.

Use a series of RDOS commands to verify the other two free-running frequencies. Verify the double-density small drive setting by typing:

O 10 34

Note that the first character is the letter "O," not the numeral zero. The remainder of this RDOS output command is composed of hexadecimal digits. After RDOS accepts the command, the frequency counter should read 250 ± 5 KHz. Large drives use this frequency for single density. Now verify the small drive single-density frequency with this command:

O 00 34

The frequency counter should read 125 ± 10 KHz. Finally, verify the large double-density frequency with:

O 50 34

It should still be 500 KHz.

20-mA teletype interface, 52

4FDC disk controller, 7

64FDC inputs, 53

64FDC outputs, 54

Address Decode, 59

Alignment Option command, 12

Auto Wait, 48, 51, 62

Auto Wait Timeout, 48

Auxiliary Disk Command register, 34

Auxiliary Disk Status register, 33

Bank select, 61

Bank Select register, 49

Baud rate, 3, 9

Baud rate register, 28

Boot command, 9, 13

Cables, 5

CDOS, 3, 4

Clocks, 61

Command format, 11

Command register, 29

CONTROL-p, 12

CONTROL-s, 12

CRC Error, 38, 43

Cromix operating system, 3, 4

Data bus, 59

Data Request, 33, 42, 44, 47, 51

Data-recovery circuit, 2

Deleted Data mark, 37

Disk Command register, 39

Disk Control register, 48

Disk drive interface characteristics, 53

Disk Flags register, 47

Disk I/O, 51

Disk Status register, 37

Diskette formatting, 7

Display Memory command, 14

Double Density, 48

DPU board, 9

Drive Select, 49

Drive Select Override*, 34

Cromemco 64FDC Instruction Manual
Index

End of Job, 48, 51
ESCAPE, 12
Examine Input Port command, 14

FD1793-1 interface, 61
Force Interrupt command, 45
Formatting diskettes, 7
Frame Error, 27
Full-Bit Detect, 27

Go command, 14

Head-movement commands, 38

In/Out Data register, 46
In/Out Sector register, 46
In/Out Track register, 46
Index holes, 7
Inhibit Init, 47
Initialize Baud Rate command, 15
Interface characteristics, 51
Internal clock, 29
Interrupt acknowledge, 29, 32, 65
Interrupt Address register, 32
Interrupt Mask register, 32
Interrupt Pending, 26
Interrupt register, 30
Interrupt-request latch, 29, 30
Interrupt-request register, 32

Jumper-selectable options, 4

List command, 15

Maxi, 49
Motor On, 47, 49
Motor Timeout, 47
Motor timer, 63
Move command, 15

Output command, 16
Overrun Error, 27

Parallel-input port, 29
Parallel-output buffers, 34
Phase-locked loop, 2, 63
Power supplies, 59
Power-on jump, 9
Priority interrupt cable, 5, 62

Query command, 16

RDOS, 11
RDOS command format, 11
RDOS editing commands, 11
RDOS select, 22
RDOS self-test, 4
Read Address command, 43
Read command, 41
Read Disk command, 16
Read Track command, 44
Real-Time Clock, 33, 66
Receiver Data Available, 26
Receiver Data register, 28
Register descriptions, 25
Restore command, 40
RETURN, 12
RS-232 interface, 5, 52

S-100 bus, 51, 59
Seek command, 17, 40
Seek In Progress, 33
Select Disk Drive command, 18
Select Request, 47
Sense Switches, 33
Serial connector, 5
Serial I/O channel, 51, 52
Serial Receive, 27
Serial receiver, 30
Serial transmitter, 30
Set Disk Side command, 17
Side Select*, 34
Start-Bit Detect, 27
Status register, 26
Step command, 40
Step In command, 40
Step Out command, 40
Substitute Memory command, 20
Swath operator, 12
Switch-selectable options, 3

Tandon TM100 disk drive, 58

Tandon TM848 disk drive, 55
Test System command, 21
Timers, 35
TMS5501, 26, 59, 60, 61
Transmitter Buffer Empty, 26
Transmitter Data register, 28
Trimmer capacitor, 2

Verify command, 21

Wait-state generator, 60
Write command, 42
Write Disk command, 22
Write precompensation, 1, 62
Write Protect, 7, 37
Write Track command, 44

ZPU board, 9

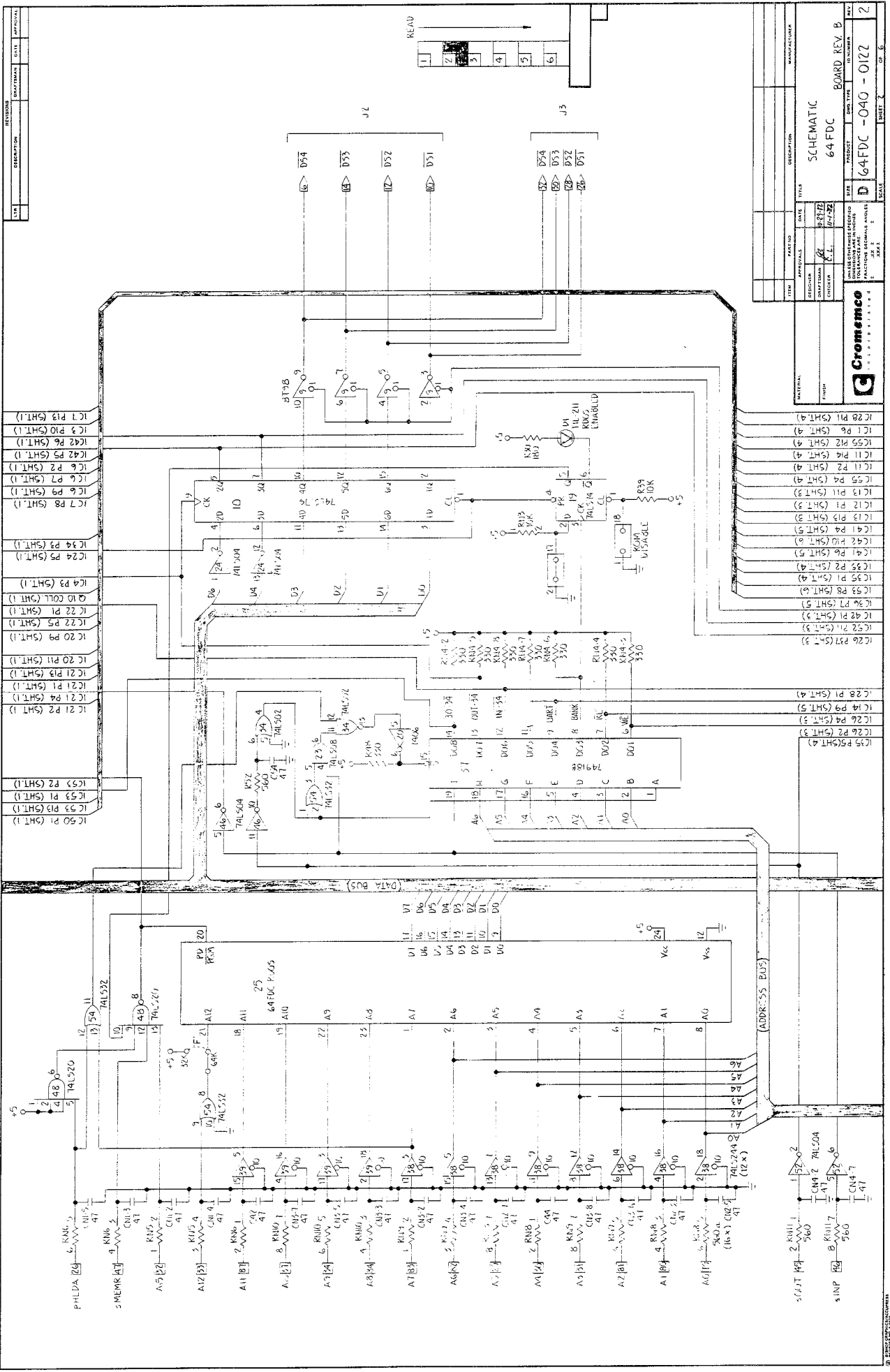

REV	DESCRIPTION	DATE	BY	APP'D
1				

ITEM	PART NO.	DATE	TITLE	MANUFACTURER
1				

ITEM	DESCRIPTION	DATE	BY	APP'D
1				

ITEM	DESCRIPTION	DATE	BY	APP'D
1				

ITEM	DESCRIPTION	DATE	BY	APP'D
1				

ITEM	DESCRIPTION	DATE	BY	APP'D
1				

ITEM	DESCRIPTION	DATE	BY	APP'D
1				

ITEM	DESCRIPTION	DATE	BY	APP'D
1				

ITEM	DESCRIPTION	DATE	BY	APP'D
1				

ITEM	DESCRIPTION	DATE	BY	APP'D
1				

ITEM	DESCRIPTION	DATE	BY	APP'D
1				

ITEM	DESCRIPTION	DATE	BY	APP'D
1				

ITEM	DESCRIPTION	DATE	BY	APP'D
1				

ITEM	DESCRIPTION	DATE	BY	APP'D
1				

ITEM	DESCRIPTION	DATE	BY	APP'D
1				

ITEM	DESCRIPTION	DATE	BY	APP'D
1				

ITEM	DESCRIPTION	DATE	BY	APP'D
1				

ITEM	DESCRIPTION	DATE	BY	APP'D
1				

ITEM	DESCRIPTION	DATE	BY	APP'D
1				

ITEM	DESCRIPTION	DATE	BY	APP'D
1				

ITEM	DESCRIPTION	DATE	BY	APP'D
1				

ITEM	DESCRIPTION	DATE	BY	APP'D
1				

ITEM	DESCRIPTION	DATE	BY	APP'D
1				

ITEM	DESCRIPTION	DATE	BY	APP'D
1				

ITEM	DESCRIPTION	DATE	BY	APP'D
1				

ITEM	DESCRIPTION	DATE	BY	APP'D
1				

ITEM	DESCRIPTION	DATE	BY	APP'D
1				

ITEM	DESCRIPTION	DATE	BY	APP'D
1				

ITEM	DESCRIPTION	DATE	BY	APP'D
1				

ITEM	DESCRIPTION	DATE	BY	APP'D
1				

ITEM	DESCRIPTION	DATE	BY	APP'D
1				

ITEM	DESCRIPTION	DATE	BY	APP'D
1				

ITEM	DESCRIPTION	DATE	BY	APP'D
1				

ITEM	DESCRIPTION	DATE	BY	APP'D
1				

ITEM	DESCRIPTION	DATE	BY	APP'D
1				

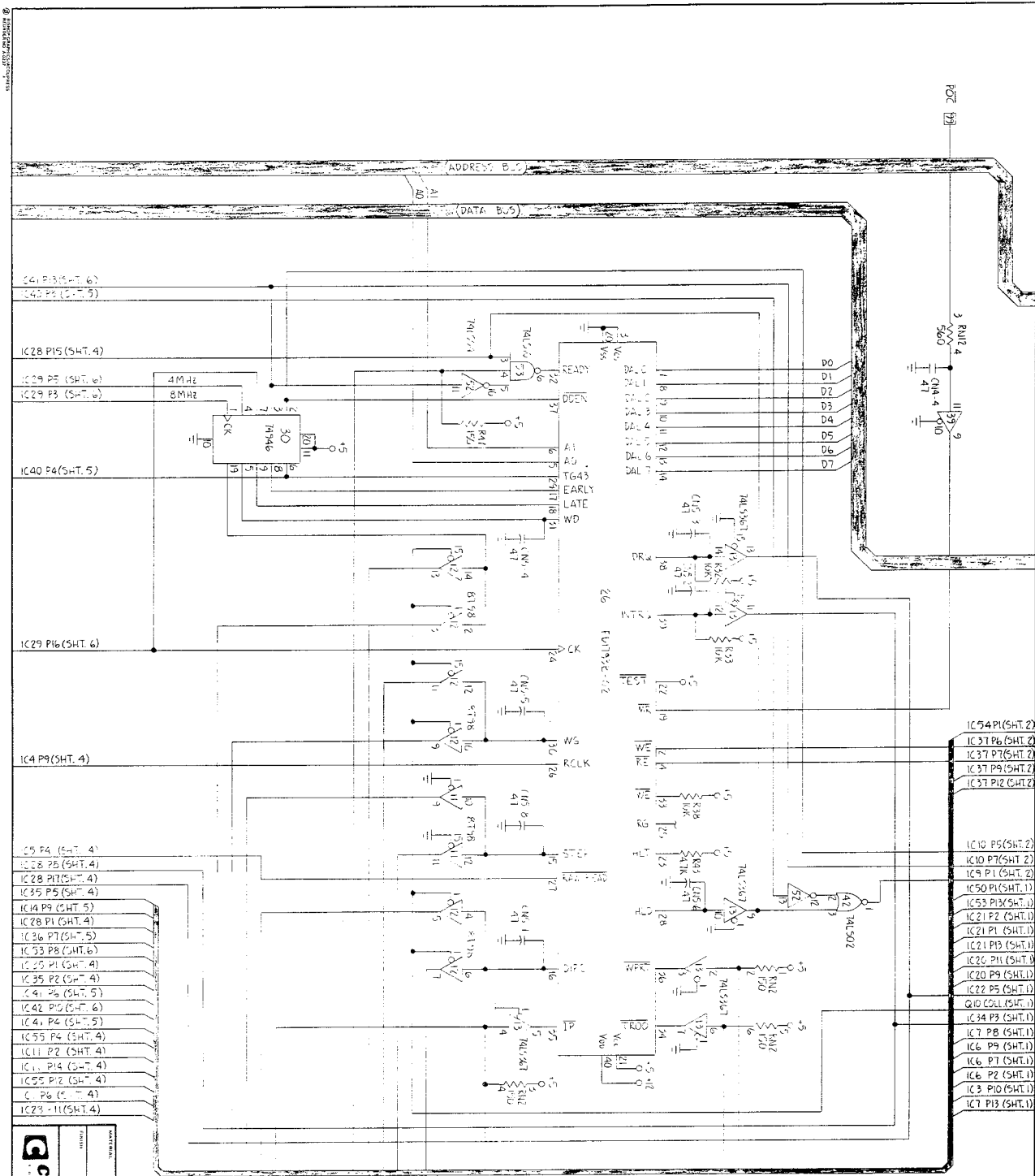

IC	DESCRIPTION	DATE	APPROVAL
IC10	P5 (SHT. 2)		
IC12	P5 (SHT. 2)		
IC19	P1 (SHT. 2)		
IC50	P1 (SHT. 1)		
IC53	P3 (SHT. 1)		
IC21	P2 (SHT. 1)		
IC21	P1 (SHT. 1)		
IC21	P3 (SHT. 1)		
IC25	P1 (SHT. 1)		
IC20	P9 (SHT. 1)		
IC22	P5 (SHT. 1)		
IC34	P3 (SHT. 1)		
IC7	P8 (SHT. 1)		
IC6	P1 (SHT. 1)		
IC6	P2 (SHT. 1)		
IC3	P10 (SHT. 1)		
IC7	P13 (SHT. 1)		
IC28	P15 (SHT. 4)		
IC29	P5 (SHT. 6)		
IC29	P3 (SHT. 6)		
IC40	P4 (SHT. 5)		
IC29	P16 (SHT. 6)		
IC4	P9 (SHT. 4)		
IC5	P4 (SHT. 4)		
IC28	P17 (SHT. 5)		
IC25	P1 (SHT. 4)		
IC35	P2 (SHT. 4)		
IC41	P5 (SHT. 5)		
IC42	P10 (SHT. 6)		
IC43	P4 (SHT. 5)		
IC55	P4 (SHT. 4)		
IC11	P2 (SHT. 4)		
IC1	P14 (SHT. 4)		
IC53	P12 (SHT. 4)		
IC76	P2 (SHT. 4)		
IC23	11 (SHT. 4)		

REV	DESCRIPTION	DATE	APPROVAL
1			
2			
3			
4			
5			
6			

REV	DESCRIPTION	DATE	APPROVAL
D	64FDC-04C-0122		

REV	DESCRIPTION	DATE	APPROVAL
2	64FDC-04C-0122		

REV	DESCRIPTION	DATE	APPROVAL
2	64FDC-04C-0122		

REV	DESCRIPTION	DATE	BY
1			

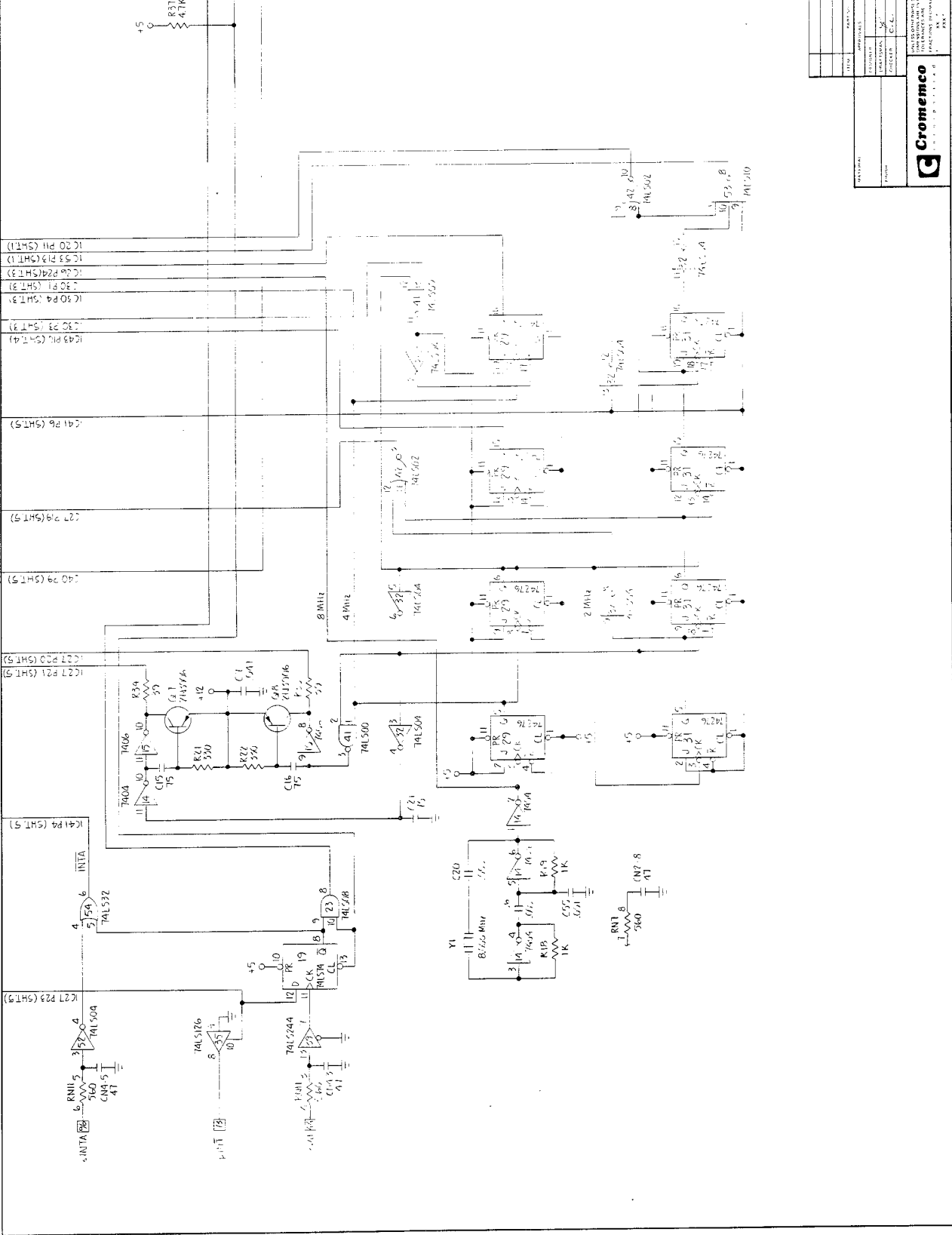

REV	DESCRIPTION	DATE	BY
1			

Cromenco
 S. B. L. S. P. A.
 VIA S. PIETRO, 10 - 20139 MILANO - ITALY
 TEL. 02/76001111 - FAX 02/76001112

PROJECT	DESIGN	DATE
...

BOARD REV. B
 SCALE: D 6441VC - 040 - 012Z - 2
 SHEET 5 OF 6

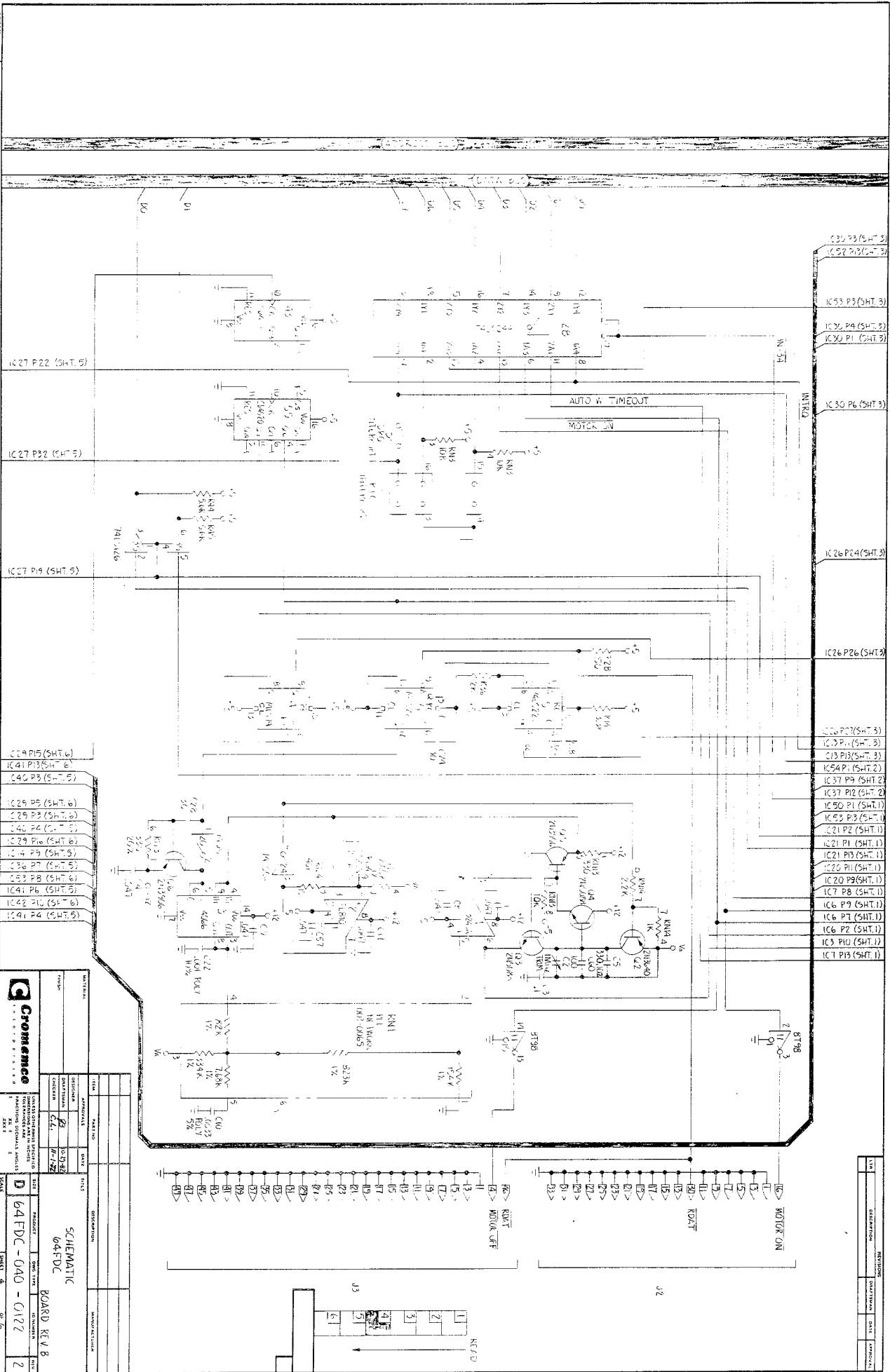

Crommece		SCHEMATIC	
64FDC - 040 - 0172		BOARD REV. 8	
DATE	REV.	DESCRIPTION	MANUFACTURER
07/28	02	64FDC - 040 - 0172	
07/28	01	64FDC - 040 - 0172	
SHEET 4		OF 8	

LIMITED WARRANTY

Cromemco, Inc. ("Cromemco") warrants this equipment against defects in material and workmanship to the original purchaser for ninety (90) days from the date of purchase, subject to the following terms and conditions.

What Is Covered By This Warranty:

During the ninety (90) day warranty period Cromemco will, at its option, repair or replace this Cromemco product or repair or replace with new or used parts any parts or components, manufactured by Cromemco, which prove to be defective, provided the product is returned to your Dealer as set forth below.

How To Obtain Warranty Service:

You should immediately notify IN WRITING your Dealer or Cromemco of problems encountered during the warranty period in order to obtain warranty service; first obtain a return authorization number by contacting the Dealer from whom you purchased the product. Then attach to the product:

1. Your name, address, and telephone number,
2. the return authorization number
3. a description of the problem, and
4. proof of the date of retail purchase

Ship or otherwise return the product, transportation and insurance costs prepaid, to your Dealer. If you are unable to receive warranty repair from the Dealer from whom you purchased the product, you should contact Cromemco Customer Support at: Cromemco, Inc., 280 Bernardo Ave., Mountain View, Ca. 94043.

What Is Not Covered By This Warranty:

Cromemco does not warrant any products, components, or parts not manufactured by Cromemco.

This warranty does not apply if the product has been damaged by accident, abuse, misuse, modification, or misapplication; by damage during shipment; or by improper service. This product is not warranted to operate satisfactorily with peripherals or products not manufactured by Cromemco. Transportation and insurance charges incurred in transporting the product to and from your Dealer or Cromemco are not covered by this warranty.

Exclusion of Liability, Damages, and Other Warranties:

THIS WARRANTY IS IN LIEU OF ALL OTHER WARRANTIES, WHETHER ORAL OR WRITTEN, EXPRESS OR IMPLIED. ANY IMPLIED WARRANTIES, INCLUDING IMPLIED WARRANTIES OF MERCHANTABILITY AND FITNESS FOR A PARTICULAR PURPOSE, ARE EXCLUDED WHERE SUCH EXCLUSION IS ALLOWED AND OTHERWISE LIMITED IN DURATION TO NINETY (90) DAYS FROM THE DATE OF PURCHASE OF THIS PRODUCT. IF THIS PRODUCT IS NOT IN GOOD WORKING ORDER AS WARRANTED ABOVE, YOUR SOLE REMEDY SHALL BE REPAIR OR REPLACEMENT AS PROVIDED ABOVE. CROMEMCO SHALL NOT BE LIABLE FOR INCIDENTAL AND/OR CONSEQUENTIAL DAMAGES FOR THE BREACH OF ANY EXPRESS OR IMPLIED WARRANTY, INCLUDING DAMAGE TO PROPERTY AND, TO THE EXTENT PERMITTED BY LAW, DAMAGES FOR PERSONAL INJURY, EVEN IF CROMEMCO HAS BEEN ADVISED OF THE POSSIBILITY OF SUCH DAMAGES. THE AGENTS, DEALERS, AND EMPLOYEES OF CROMEMCO ARE NOT AUTHORIZED TO MAKE MODIFICATIONS TO THIS WARRANTY, OR ADDITIONAL WARRANTIES BINDING ON CROMEMCO ABOUT OR FOR PRODUCTS SOLD OR LICENSED BY CROMEMCO. ACCORDINGLY, ADDITIONAL STATEMENTS WHETHER ORAL OR WRITTEN EXCEPT SIGNED WRITTEN STATEMENTS FROM AN OFFICER OF CROMEMCO DO NOT CONSTITUTE WARRANTIES AND SHOULD NOT BE RELIED UPON. SOFTWARE, TECHNICAL INFORMATION, AND FIRMWARE ARE LICENSED ONLY BY A SEPARATE AGREEMENT ON AN "AS IS" BASIS.

Limitation on Statute of Limitation and Transferability:

THIS WARRANTY AND THE STATUTE OF LIMITATIONS SHALL RUN CONCURRENTLY WITH ANY ACCEPTANCE PERIOD. THIS WARRANTY IS NOT TRANSFERABLE. NO SUIT, LITIGATION, OR ACTION SHALL BE BROUGHT BASED ON THE ALLEGED BREACH OF THIS WARRANTY OR IMPLIED WARRANTIES OR FOR OTHER CAUSE MORE THAN ONE YEAR AFTER THE DATE OF PURCHASE IN THOSE JURISDICTIONS ALLOWING SUCH A LIMITATION; OTHERWISE NO SUCH ACTION SHALL BE BROUGHT MORE THAN ONE YEAR AFTER THE EXPIRATION OF THIS WARRANTY.

Other Important Provisions:

Some states do not allow the exclusion or limitation of incidental or consequential damages or limitations on how long an implied warranty lasts, so the above limitation or exclusion may not apply to you. This warranty shall not be applicable to the extent that any provision of this warranty is prohibited by any federal, state, or municipal law which cannot be preempted. This warranty gives you specific legal rights, and you may also have other rights which vary from state to state.

Reader Responses To This Documentation

Dear Reader,

We have made a sincere effort to provide you with the information you need in this manual. If you should find the documentation deficient or in error, let us know so we can correct it. We appreciate and value your response; it will be useful in improving the documentation. Please detach and use the Reader Response Card below to send us your comments.

Thank you for your time and interest in Cromemco products.

Sincerely,

Winthrop A. Stiles III
Technical Publications Manager

(Detach Here)

Cromemco[®]

Reader Response Card

To: Winthrop A. Stiles III,
Technical Publications Manager

Re (Manual title): _____

My System is (Specify configuration): _____

The following information is incorrect (Please specify page number): _____

(Detach Here)

(Fold Here)

The following additional information would be helpful: _____

What general suggestions do you have for improving this manual? _____

If you need a response from Cromemco, please print your name, mailing address, and telephone number:

Name: _____

Address: _____

Telephone: () _____



NO POSTAGE
NECESSARY
IF MAILED
IN THE
UNITED STATES

BUSINESS REPLY MAIL
FIRST CLASS PERMIT NO. 599 MOUNTAIN VIEW, CA

POSTAGE WILL BE PAID BY ADDRESSEE

Cromemco[®]

Attn: Winthrop A. Stiles III
Technical Publications Manager
280 Bernardo Avenue
P.O. Box 7400
Mountain View, CA 94039

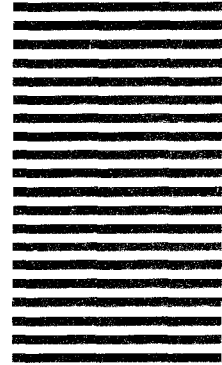

Cromemco[®]

280 BERNARDO AVE., MOUNTAIN VIEW, CA 94043